

# eternoivica

Catalogo | Catalog  
2022



ETERNO



LIQUID

**IT**                    **Accessori per l'impermeabilizzazione di coperture e terrazze.**

Prodotti per l'impermeabilizzazione quali bocchettoni, esalatori ed angolari, interamente pensati e realizzati con materiale compatibile sia a membrane bituminose che sintetiche.

.....





**EN**                    ***Accessories for flat roofs and terraces waterproofing.***

*Waterproofing products such as drains, exhalators and angles, all designed and made with material compatible with both bituminous and synthetic membranes.*









**LEGENDA MATERIALI**  
MATERIAL INDEX

<b>INOX</b>	Acciaio Inox <i>Stainless Steel</i>
<b>CU</b>	Rame <i>Copper</i>
<b>ZN</b>	Zinco <i>Zinc</i>
<b>MBP</b>	Membrana bituminosa polimerica <i>Polymeric bituminous membrane</i>
<b>GOMMA RUBBER</b>	Gomma vulcanizzata <i>Vulcanized rubber</i>
<b>TPE</b>	Elastomero termoplastico (gomma termoplastica) <i>Thermoplastic elastomer (thermoplastic rubber)</i>
<b>PVC</b>	Cloruro polivinile <i>Polyvinyl chloride</i>
<b>TPO</b>	Poliiolefine <i>Polyolefin</i>
<b>PP</b>	Polipropilene <i>Polypropylene</i>
<b>PE</b>	Polietilene <i>Polyethylene</i>

**LEGENDA APPLICAZIONI**  
APPLICATIONS INDEX

	Applicazione a colla/freddo con pennello <i>Glue/cold application with brush</i>
	Applicazione a fiamma <i>Torch-on application</i>
	Applicazione aria calda <i>Hot air application</i>
	Applicazione membrana liquida, cemento bicomponente con rullo <i>Liquid waterproofing, cementitious bicomponent application with roll</i>

**LEGENDA COMPATIBILITÀ PRODOTTI "ETERNO" E "LIQUID"**  
COMPATIBILITY INDEX "ETERNO" AND "LIQUID" PRODUCTS

	Membrane impermeabilizzanti bitume polimero: elastomeriche, elastoplastomeriche, plastomeriche <i>Bitumen-polymer waterproofing membranes: elastomeric, elastoplastomeric, plastomeric</i>
	Membrane in gomma EPDM <i>EPDM rubber membranes</i>
	Membrane sintetiche in PVC <i>PVC synthetic membranes</i>
	Membrane sintetiche in TPO <i>TPO synthetic membranes</i>
	Membrane sintetiche in ECB e bituminosi in SBS <i>ECB synthetic and SBS bituminous membranes</i>
	Qualsiasi tipo di membrana impermeabile <i>Any type of waterproofing membrane</i>
	Bitume ossidato, guaina liquida a freddo, cemento bicomponente <i>Oxidized bitumen, cold liquid membrane, two-component cement</i>
	Resine poliuretaniche ed epossidiche <i>Polyurethane and epoxy resins</i>

NB.: Le misure indicate nel presente catalogo sono espresse in mm, salvo diverse indicazioni.  
NB.: All measures in this catalogue are expressed in mm, if not otherwise indicated.

**LINEA ETERNO ETERNO LINE** 04

Introduzione *Introduction*

**ACCESSORI PER MEMBRANA BITUME POLIMERO**  
**POLYMER-BITUMEN MEMBRANE ACCESSORIES** 08

Bocchettoni "revolution" in MBP	<i>"Revolution" MBP roof drain</i>
Bocchettoni "eterno" EPDM	<i>"Eterno" EPDM rubber roof drain</i>
Bocchettoni "genius" in TPE	<i>Roof drain "genius" made of TPE</i>
Bocchettoni "euro" in TPE	<i>"Euro" roof drain made of TPE</i>
Bocchettoni "mondial" in TPE	<i>"Mondial" roof drain made of TPE</i>
Bocchettoni verticali e laterali	<i>Side and vertical roof drain</i>
Bocchettoni angolari in TPE	<i>TPE angular drains</i>
Esalatori in TPE	<i>TPE roof vents</i>
Raccordi per tubi in gomma EPDM e TPE	<i>EPDM rubber and TPE base fittings for pipes</i>
Angoli in TPE	<i>TPE corners</i>

**ACCESSORI PER MEMBRANE SINTETICHE IN PVC**  
**ACCESSORIES FOR PVC SYNTHETIC MEMBRANES** 56

Bocchettone "euro" in PVC	<i>"Euro" PVC drains</i>
Bocchettoni angolari in PVC	<i>PVC angular drains</i>
Esalatori in PVC semplici e doppi	<i>Simple wall and double wall PVC roof vents</i>
Angoli in PVC	<i>PVC corner</i>
Raccordi in PVC	<i>PVC base fitting</i>
Profili perimetrali in PVC	<i>PVC profiles</i>

**ACCESSORI PER MEMBRANE SINTETICHE IN POLIOLEFINE (TPO)**  
**ACCESSORIES FOR TPO LAYERS** 72

Bocchettoni "euro" in TPO	<i>"Euro" TPO roof drain</i>
Bocchettoni angolari in TPO	<i>Angular TPO drain</i>
Esalatori in TPO	<i>TPO wall polyolefene roof vent</i>
Angoli in TPO	<i>TPO corner</i>
Raccordi e profili perimetrali in TPO	<i>TPO base fittings and profiles</i>

**PARAFOLGIA E PARAGHIAIA**  
**LEAF-GUARDS AND GRAVEL-GUARD** 82

Parafoglia standard in PP	<i>PP standard leaf-guard</i>
Parafoglia universale in PP	<i>PP universal leaf-guard</i>
Parafoglia angolare	<i>Leaf-guard for angular drain</i>
Parafoglia universale in zinco, rame, acciaio	<i>Flexible zinc, copper, stainless steel leaf-guard</i>
Paraghiaia, prolunga, asta	<i>Gravel-guard, extension ring, universal adaptor</i>
Paraghiaia spagna e rete proteggi gronde	<i>Gravel-guard spain and eaves gutter-guard</i>

**SALVASPORGENZE E PETTINI ANTINIDO**  
**EAVE-COMB FILLER AND ANTI-NEST COMB** 90

Salvasporgenze in PP	<i>PP eave comb filler</i>
Salvasporgenze metallico "standard"	<i>"Standard" metal eave comb filler</i>
Salvasporgenze metallico "special"	<i>"Special" metal eave comb filler</i>
Salvasporgenze metallico "inox"	<i>"Inox" metal eave comb filler</i>
Pettine antinido in PP	<i>PP anti-nest comb</i>
Pettine antinido in lamiera preverniciata	<i>Anti-nest comb in pre-painted sheet metal</i>
Pettine antinido in rame	<i>Copper anti-nest comb</i>

**LINEA LIQUID LIQUID LINE** 96

Introduzione *Introduction*

**ACCESSORI PER MEMBRANE LIQUIDE**  
**ACCESSORIES FOR LIQUID MEMBRANES** 100

Kit liquid con flangia in TNT	<i>Liquid kit with TNT flange</i>
Kit liquid con flangia in fibra di vetro	<i>Liquid kit with fiberglass flange</i>
Accessori	<i>Accessories</i>
Bocchettoni angolari	<i>Angular drain</i>
Esalatori per impermeabilizzazioni liquide	<i>Vent pipe for liquid waterproofing</i>
Canaletta doccia "liquid" in PP	<i>"Liquid" shower channel PP</i>

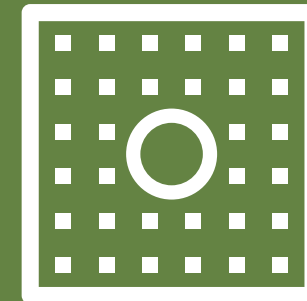

# LINEA ETERNO

---

ETERNO LINE



# INTRODUZIONE

## INTRODUCTION

IT

**Ricerca continua e innovazione tecnologica per sistemi di impermeabilizzazione di altissima qualità.**

Quella di Eterno Ivica è la storia di specialisti assoluti delle impermeabilizzazioni. Tutto comincia negli anni '50 dall'esperienza di Ruggero Favero che dopo aver guidato un'azienda specializzata nella posa di membrane la IVICA (Industria Veneta Idrofughi Catrami ed Affini) fonda nel 1973 la Eterno SAS e nel 1980 nasce l'attuale ETERNO IVICA. I primi prodotti sono bocchettoni per guaine impermeabili, un campo di utilizzo che l'azienda continuerà a rivoluzionare e perfezionare. Oggi è il figlio di Ruggero, Gabriele Favero a guidare la Eterno Ivica, sempre all'avanguardia nell'evoluzione tecnica e tecnologica del settore.

Eterno Ivica, grazie a investimenti costanti in ricerca e sviluppo e un'attenzione irrinunciabile alla qualità, ha creato soluzioni innovative, funzionali ed efficaci, in grado di rispondere in maniera puntuale alle più variegata esigenze dell'edilizia moderna.

I prodotti e i sistemi della gamma Eterno sono studiati e ingegnerizzati per esaltare la bellezza del progetto, massimizzare l'efficacia della costruzione, incrementare la durata e il valore degli edifici.

EN

**Continuous research and technological innovation for the highest quality waterproofing systems.**

*The history of Eterno Ivica is one of experts operating in the field of waterproofing.*

*It all dates back to the 1970s, when Ruggero Favero, after having gained experience with a company specializing in the installation of membranes, founded IVICA (Industria Veneta Idrofughi Catrami ed Affini). The company's first products were drain outlets for waterproof roofing felts, a range of products that the company would continue to revolutionize and perfect. The company is currently led by Ruggero's son, Gabriele Favero, who is dedicated to ensuring that Eterno Ivica will always remain at the forefront in terms of the industry's technical and technological developments.*

*Eterno Ivica, thanks to its constant investments in research and development and an indispensable attention to quality, has created innovative, functional and effective solutions, able to respond in a timely manner to the most varied demands of modern construction.*

*Eterno products range and systems are designed and engineered to enhance the beauty of your project, maximize the effectiveness of construction, increasing the duration and value of the buildings.*

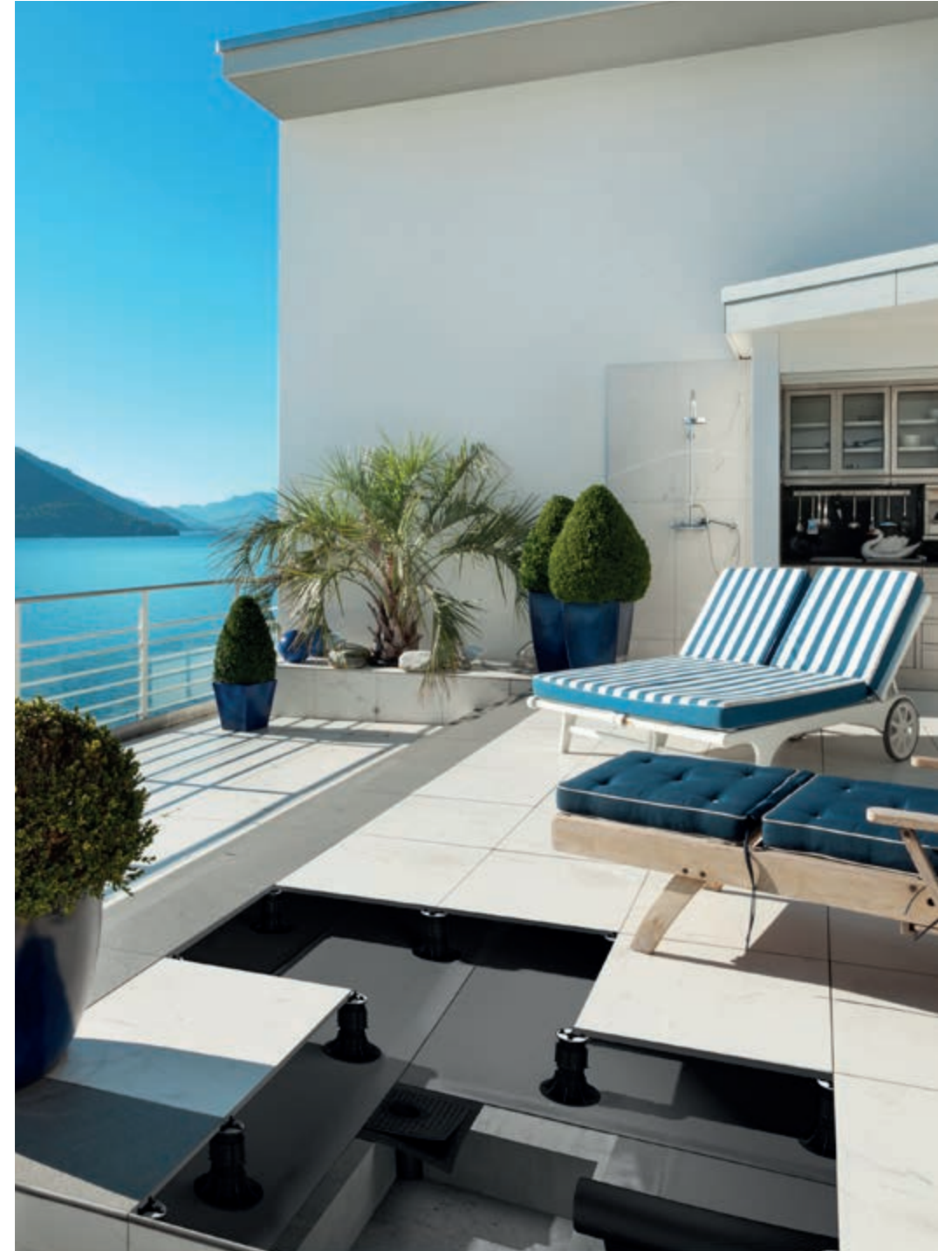

# ACCESSORI PER MEMBRANA BITUME POLIMERO

**POLYMER-BITUMEN  
MEMBRANE ACCESSORIES**

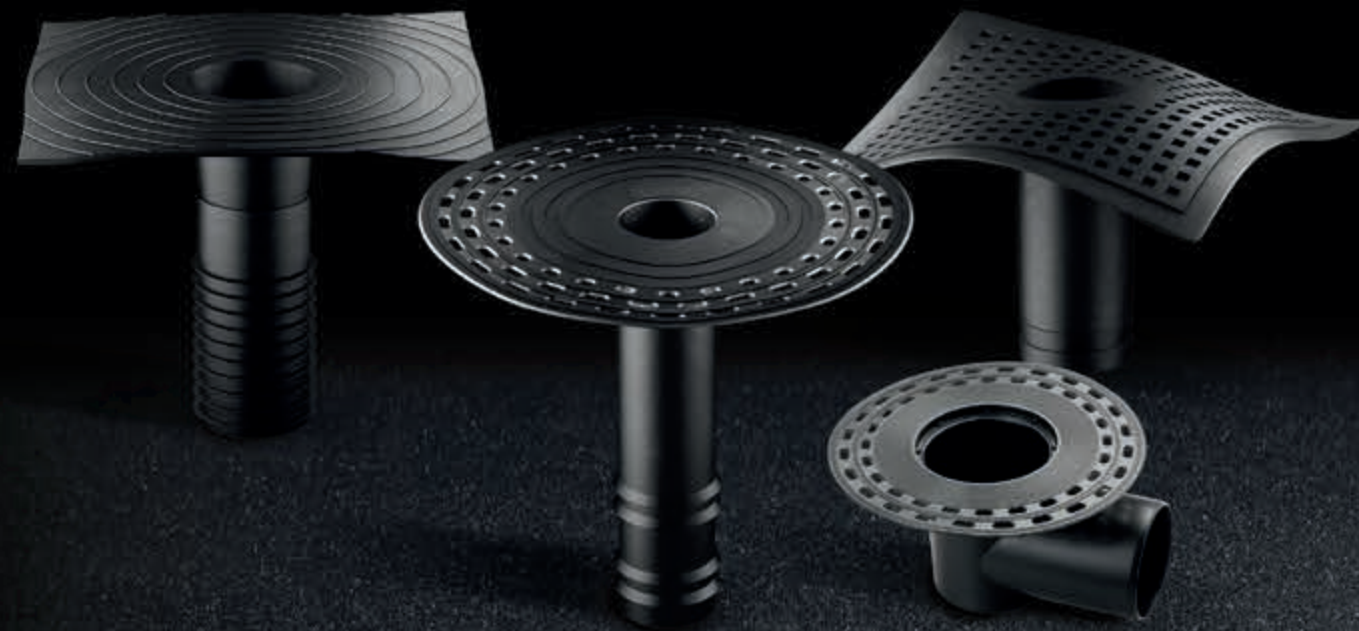

BOCCHETTONI "REVOLUTION" IN MBP  
*"REVOLUTION" MBP ROOF DRAIN*

BOCCHETTONI "ETERNO" EPDM  
*"ETERNO" EPDM RUBBER ROOF DRAIN*

BOCCHETTONI "GENIUS" IN TPE  
*ROOF DRAIN "GENIUS" MADE OF TPE*

BOCCHETTONI "EURO" IN TPE  
*"EURO" ROOF DRAIN MADE OF TPE*

BOCCHETTONI "MONDIAL" IN TPE  
*"MONDIAL" ROOF DRAIN MADE OF TPE*

BOCCHETTONI VERTICALI E LATERALI  
*SIDE AND VERTICAL ROOF DRAIN*

BOCCHETTONI ANGOLARI IN TPE  
*TPE ANGULAR DRAINS*

ESALATORI IN TPE  
*TPE ROOF VENTS*

RACCORDI PER TUBI IN GOMMA EPDM E TPE  
*EPDM RUBBER AND TPE BASE FITTINGS FOR PIPES*

ANGOLI IN TPE  
*TPE CORNERS*



# BOCCHETTONI "REVOLUTION"

"REVOLUTION" ROOF DRAINS

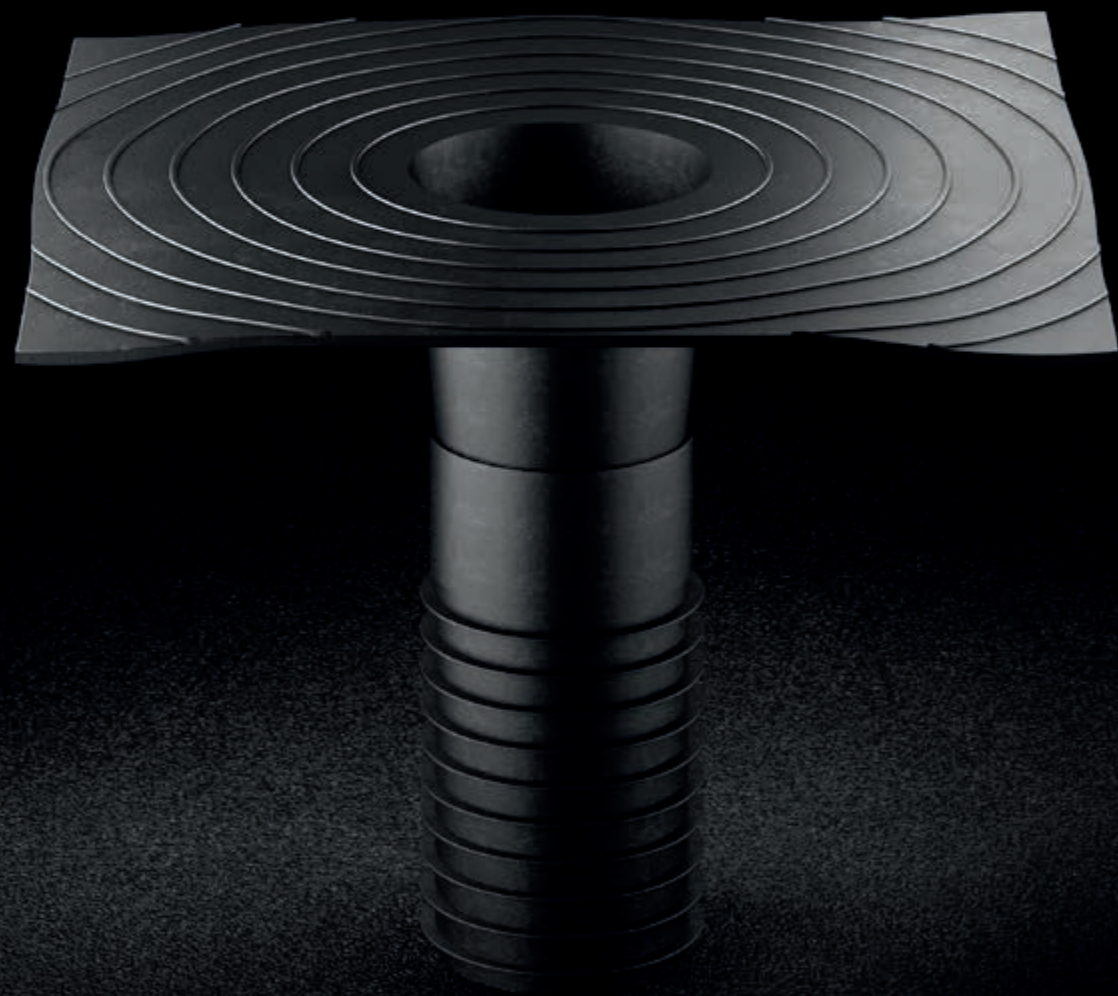

MBP

MBP



## BOCCHETTONE ETERNO "REVOLUTION" IN MBP

### "REVOLUTION" ROOF DRAINS MADE OF POLYMERIC BITUMINOUS MEMBRANE

IT

Ancora una volta ETERNO IVICA rivoluziona il mondo degli accessori per le impermeabilizzazioni. La rivoluzione sta nella flangia, costituita da un fazzoletto di membrana bituminosa appositamente termoformata. La rivoluzione sta nell'adesione, assolutamente rapida e perfetta con qualsiasi membrana bituminosa, sia in mono strato sia in doppio strato. La rivoluzione sta nel codolo h 450 mm e h 250 mm, l'unico sul mercato con 10 alette veramente anti-reflusso per prevenire qualsiasi infiltrazione tra bocchettone e tubo di scarico. Visto lo spessore della membrana, si consiglia di fare attenzione al diametro effettivo di uscita del bocchettone.

EN

Once again ETERNO IVICA does a revolution in the world of accessories for waterproofing systems. Revolution stays in the flange made of a piece of polymeric modified bituminous membrane. Revolution stays also in the adhesion, totally perfect and quick to any sort of bituminous membrane, both in single or double layer. Revolution stays ultimately in the spigot 450mm and 250 mm long, the one in the market with 10 real anti-infiltration tongues to prevent any infiltration between spigot and pipe in case of water back-up. Due to the thickness of the bituminous membrane, we please you pay attention to the real internal size of the drain.



Bocchettone "Revolution"  
con codolo h 250 mm  
"Revolution" Roof Drain  
h 250 mm



Bocchettone "Revolution"  
con codolo h 450 mm  
"Revolution" Roof Drain  
h 450 mm

## DESCRIZIONE

### DESCRIPTION

- 1 Flangia morbida e adattabile a scarichi verticali ed orizzontali  
*Soft flange that can be adapted to both vertical and horizontal drainpipes*
- 2 Interamente stampato-termoformato, in membrana bitume-polimero armata  
*Totally stamped-thermoformed in reinforced polymer-bitumen membrane*
- 3 Predisposizione per l'inserimento di parafoglia  
*Predisposed for the installation of a leaf-guard*
- 4 Ampia flangia zigrinata per maggiore adesione  
*Large knurled flange for improved adhesion*
- 5 Raccordo rinforzato da 8 strati di armatura + MBP  
*Reinforced connector, comprised of 8 reinforcement layers + MBP*
- 6 Codolo H 250 e 450 mm  
*250 mm and 450 mm H shank*
- 7 10 alette antiriflusso spessore 10 mm  
*10 backflow flaps thickness 10 mm*



## VANTAGGI

### ADVANTAGES

IT

- Ampia gamma di misure per tubi da Ø 75 a Ø 125
- Adattabile a qualsiasi tipo di pluviale di scarico
- Alta resistenza alla fiamma
- Ampia flangia
- Codolo speciale in gomma con 10 alette antiriflusso

EN

- *Wide range of sizes for pipes of Ø 75 to Ø 125*
- *Adaptable to any type of drainpipe*
- *Exceptional fire resistance*
- *Wide flange*
- *Special rubber spigot provided with 10 anti-infiltration tongues*





**Bocchettone "Revolution" h 250 mm e 450 mm**  
 "Revolution" roof drain h 250 mm and 450 mm

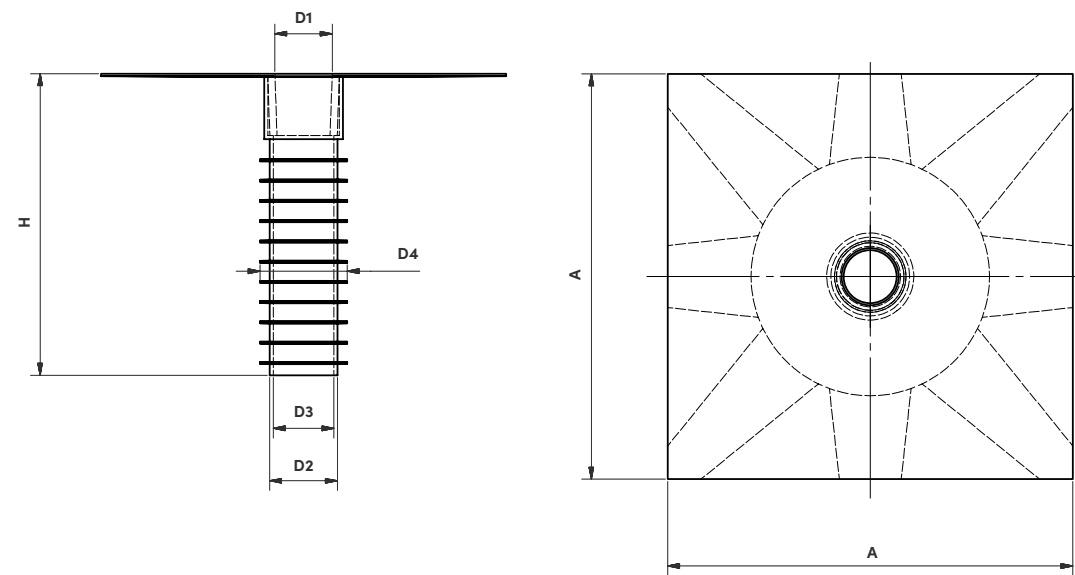

CODICE CODE	PER TUBI FOR PIPES	A	D1	D2	D3	D4	H	PAG LISTINO PRICE LIST PAGE	PZ 	PZ 
A310250075	Ø 75	340	52	(57)	52	75	250	6	4	64
A310250082	Ø 82	340	59	(65)	59	80	250	6	4	64
A310250090	Ø 90	340	65	(72)	65	87	250	6	4	64
A310250100	Ø 100	340	76	(83)	76	95	250	6	4	64
A310250110	Ø 110	340	85	(90)	85	110	250	6	4	64
A310250125	Ø 125	340	97	(103)	97	120	250	6	4	64
A310450075	Ø 75	340	65	(57)	52	75	450	6	4	64
A310450082	Ø 82	340	75	(65)	59	80	450	6	4	64
A310450090	Ø 90	340	80	(72)	65	87	450	6	4	64
A310450100	Ø 100	340	90	(83)	76	95	450	6	4	64
A310450110	Ø 110	340	100	(90)	85	110	450	6	4	64
A310450125	Ø 125	340	115	(103)	97	120	450	6	4	64



**Angoli prefabbricati in membrana bituminosa polimerica**  
 Prefabricated corners made of polymeric bituminous membrane

IT

Gli angoli prefabbricati bituminosi sono ottenuti dalla piegatura a caldo di un pezzo unico di membrana bituminosa con armatura composita. Il principale vantaggio è la totale fusione con la membrana bituminosa unita alla praticità e alla flessibilità di posa, offrendo maggiore garanzia di tenuta nei punti più a rischio di infiltrazione.

EN

The bituminous prefabricated corners are made by hot folding of a unique piece of bituminous membrane with composite reinforcement. The main advantage is the total melting to the waterproofing sheet as long as their flexibility during installation which give a total waterproofing guarantee on the most risky points.

**ANGOLI BITUMINOSI INTERNI**  
 INTERNAL BITUMINOUS CORNERS

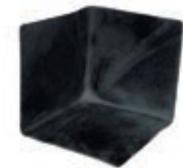
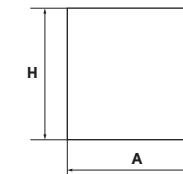

**ANGOLI BITUMINOSI ESTERNI**  
 EXTERNAL BITUMINOUS CORNERS

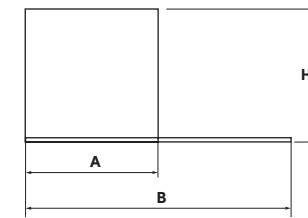

**PROFILO ANGOLARE "STRIPE-BIT"**  
 "STRIPE-BIT" CANT PROFILE



CODICE CODE	PER TUBI FOR PIPES	L	A	B	C	H	PAG LISTINO PRICE LIST PAGE	PZ 	PZ 
F011004060	Angolo interno Internal corner	-	200	-	-	200	6	10	-
F010004060	Angolo esterno External corner	-	162	335	-	170	6	10	-
A300454560	Stripe-Bit Stripe-Bit	1100	45	45	60	-	7	24	-

Il profilo angolare STRIPE-BIT, come per gli angoli bituminosi, è ottenuto dalla piegatura a caldo di una membrana bituminosa con armatura composita. La sua lunghezza è di 110 cm.

Like with bituminous corner profiles, the STRIPE-BIT corner profile is obtained via the hot bending of a bituminous membrane with composite reinforcement. It has a length of 110 cm.

# BOCCHETTONI "ETERNO" EPDM

"ETERNO" EPDM RUBBER ROOF DRAIN



GOMMA  
RUBBER

MBP



## BOCCHETTONE "ETERNO" IN GOMMA EPDM

### "ETERNO" EPDM RUBBER ROOF DRAIN

IT

Fra gli accessori per il deflusso delle acque meteoriche proposti da Eterno Ivica troviamo la gamma di bocchettoni "Eterno" completamente realizzati in gomma EPDM, un materiale caratterizzato da un'elevata resistenza alla fiamma. I bocchettoni in gomma EPDM sono provvisti di una flangia ampia e morbida, adattabile a qualsiasi superficie, con zigrinature sulla parte inferiore. La particolare forma del codolo è studiata per aumentare l'azione "antiriflusso".

EN

Among the accessories for rainwater drainage produced by Eterno Ivica we can find the "Eterno" drains, completely made of EPDM rubber, a material has a high resistance to flame. EPDM rubber drains are equipped with a wide and soft flange, adaptable to any surface. The particular shape of the spigot is designed to increase "anti-infiltration" effect.



Bocchettone in EPDM  
con codolo h 200 mm e h 500mm  
"Eterno" EPDM Rubber Roof Drain with a  
200 mm and 500 mm



Bocchettone  
in EPDM Sifonato  
EPDM Rubber Roof Drain  
with trap

## DESCRIZIONE

## DESCRIPTION

- 1 Flangia morbida e adattabile a scarichi verticali ed orizzontali  
*Soft flange that can be adapted to both vertical and horizontal drainpipes*

- 2 Spigolo rinforzato  
*Reinforced edge*

- 3 Predisposizione per l'inserimento di parafoglia  
*Predisposed for the installation of a leaf-guard*

- 4 Bassorilievi a "coda di rondine" per favorire l'aggancio del bitume fuso  
*"Dovetail" bas-relief to facilitate the attachment of the cast bitumen*

- 5 Parte inferiore della flangia dotata di zigrinature  
*Knurled flange bottom*

- 6 Particolare forma del codolo studiata per aumentare l'azione "antiriflusso"  
*Special shank form designed to favour the "backflow prevention" effect*

- 7 Prolunga rigida  
*Rigid extension*

- 8 Particolare forma del codolo studiata per aumentare l'azione "antiriflusso"  
*Terminal part of the extension element predisposed for the insertion of extensions*

- 9 Prolunga a soffietto  
*Sliding extension*

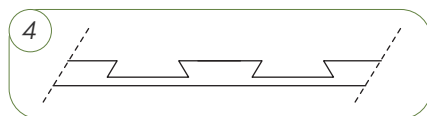

## VANTAGGI

## ADVANTAGES

IT

- Ampia gamma di misure per tubi da Ø 40 a Ø 200
- Adattabile a qualsiasi tipo di pluviale di scarico
- Alta resistenza alla fiamma
- Ampia flangia

EN

- *Wide range of sizes for pipes of Ø 40 to Ø 200*
- *Adaptable to any type of drainpipe*
- *Exceptional fire resistance*
- *Wide flange*





## Bocchettone in gomma EPDM con codolo h 200 mm

### "Eterno" EPDM rubber roof drain with a 200 mm spigot

IT



Interamente prodotto in gomma EPDM, è il primo, storico bocchettone di scarico inventato da ETERNO IVICA. Invariate nel tempo le intaccature a coda di rondine sulla flangia per una perfetta adesione alla membrana bituminosa ed il codolo cilindrico per una perfetta tenuta al pluviale di scarico.

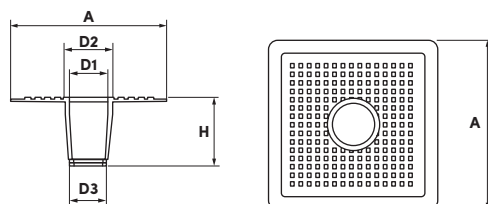

EN

Entirely manufactured in EPDM rubber, it is the very first historical roof drain invented by ETERNO IVICA. The exclusive dove-tail notches on the flange for a perfect bond to any bituminous membrane and the cylindrical spigot are still the same.



CODICE CODE	PER TUBI FOR PIPES	A	D1	D2	D3	H	PAG LISTINO PRICE LIST PAGE	PZ 	PZ 
A001020040	Ø 40	250	33	39	31	175	7	25	1050
A001020050	Ø 50	310	45	50	42	200	7	25	500
A001020060	Ø 60	305	51	57	49	200	7	25	500
A001020075	Ø 75	340	66	72	63	200	7	25	400
A001020080	Ø 80	330	74	80	70	200	7	25	400
A001020090	Ø 90	330	80	86	78	200	7	25	400
A001020100	Ø 100	340	93	99	87	200	7	25	400
A001020110	Ø 110	340	99	105	94	200	7	25	400
A001020120	Ø 120	340	113	119	107	200	7	25	400
A001020125	Ø 125	370	116	122	113	200	7	20	320
A001020140	Ø 140	370	132	138	124	200	7	20	320
A001020150	Ø 150	390	140	146	132	200	7	15	240
A001020160	Ø 160	360	150	156	146	200	7	15	240
A001020200	Ø 200	440	189	195	179	210	7	10	80



## Bocchettone in gomma EPDM sifonato

### EPDM rubber roof drain with trap

IT

Interamente prodotto in gomma EPDM, corredato dal tradizionale codolo per l'innesco nel pluviale e dalla flangia per l'ancoraggio della membrana impermeabile, questo bocchettone è munito inoltre di una cupola per la sifonatura. Il bocchettone sifonato è venduto completo di cupola e parafoglia.



EN

Entirely manufactured in EPDM rubber, it consists of the traditional spigot that fits any kind of drain-pipe, the flange with the exclusive dove tail notches for a perfect bond to the membrane and a tank to collect the rain water. This roof drain is delivered with dome and leaf-guard.

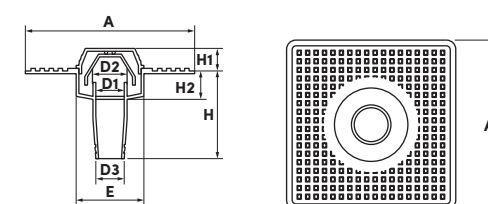

CODICE CODE	PAG LISTINO PRICE LIST PAGE	A	D1	D2	D3	E	H	H1	H2	PAG LISTINO PRICE LIST PAGE	PZ 	PZ 
A031000080	Ø 80	393	90	97	68	170	205	55	70	7	5	125
A031000090	Ø 90	363	93	100	78	170	205	55	70	7	5	125
A031000100	Ø 100	393	90	100	87	170	205	55	70	7	5	125
A031000110	Ø 110	363	100	107	94	170	205	55	70	7	5	125



> POSA IN OPERA ACCESSORI PER MANTI BITUMINOSI APP-SBS  
> INSTALLATION OF ACCESSORIES FOR BITUMINOUS MEMBRANES APP-SBS

**Anelli antiriflusso per bocchettone in gomma EPDM h 200 mm****Retro fit adaptors for EPDM roof drains h 200 mm**

IT

Gli anelli antiriflusso sono stati sviluppati per adattare i bocchettoni in EPDM ai tubi tipo "GEBERIT" oppure ad altre tipologie le cui misure sono espresse in pollici (inches).

EN

The retro-fit adaptors have been specifically developed to allow the EPDM rubber roof drains to perfectly fit any kind of "GEBERIT" drain-pipes or other types of pipes whose sizes are expressed in inches.

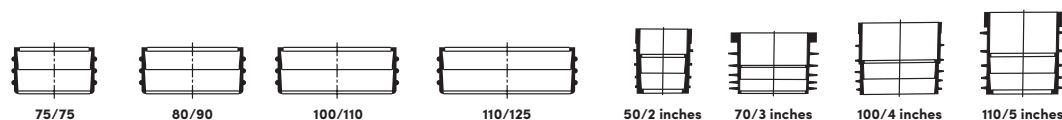

CODICE CODE	MISURA SIZE	PAG LISTINO PRICE LIST PAGE	PZ	PZ
F080075075	Ø 75 - 75	8	25	1750
F080080090	Ø 80 - 90	8	25	1750
F080100110	Ø 100 - 110	8	25	1750
F080110125	Ø 110 - 125	8	25	1750
F081050000	Ø 50 - 2 inches	8	25	1750
F081075000	Ø 75 - 3 inches	8	25	1750
F081100000	Ø 100 - 4 inches	8	25	1750
F081110000	Ø 110 - 5 inches	8	25	1750

GOMMA  
RUBBERGOMMA  
RUBBER**Prolunghe per bocchettone in gomma EPDM****Extensions for EPDM roof drain**

IT

Adattabile al bocchettone in gomma EPDM H mm 200 e al bocchettone sifonato. Qualora si presenti la necessità di allungare il codolo di scarico del bocchettone, esistono delle intaccature per l'applicazione di prolunghe in gomma EPDM rigide o a soffietto.

EN

These rubber extensions are suitable to "Eterno" roof drains made of EPDM rubber with a 200 mm spigot and to roof drains with trap only. If there should be any need to make the spigot longer, this range of rigid and flexible extensions is available.

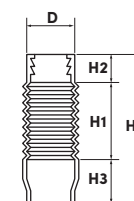
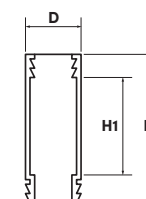
**PROLUNGA IN GOMMA EPDM  
EPDM RUBBER EXTENSION**

CODICE CODE	Ø	D	H	H1	PAG LISTINO PRICE LIST PAGE	PZ	PZ
B002020060	60	50	230	165	8	25	1750
B002020075	75	65	228	150	8	25	1350
B002020080	80	73	225	155	8	25	1050
B002020090	90	85	192	125	8	25	1050
B002020100	100	85	225	170	8	25	625
B002020110	110	95	230	170	8	25	625
B002020120	120	110	227	155	8	20	400
B002020125	125	115	245	165	8	20	320
B002020140	140	130	230	150	8	15	320
B002020150	150	140	240	155	8	15	240
B002020160	160	150	227	145	8	15	240
B002020200	200	190	237	150	8	10	160

**PROLUNGA A SOFFIETTO IN GOMMA EPDM  
EPDM RUBBER FLEXIBLE EXTENSION**

CODICE CODE	Ø	D	H	H1	H2	H3	PAG LISTINO PRICE LIST PAGE	PZ	PZ
B001020075	75	70	280	145	45	90	8	25	500
B001020080	80	75	280	145	45	90	8	25	500
B001020100	100	90	280	145	45	90	8	25	400
B001020120	120	110	280	155	40	85	8	25	400
B001020125	125	115	280	170	35	85	8	25	320

### Bocchettone in gomma EPDM con codolo h 500 mm EPDM rubber roof drain with a 500 mm spigot

IT

Questa particolare tipologia di bocchettone in EPDM è provvista di un codolo lungo 500 mm rinforzato sul fondo da un anello interno in plastica rigida. Proprio la lunghezza del codolo lo rende particolarmente adatto ad una applicazione su tetti industriali.



EN

*This particular type of EPDM roof drain has a 500 mm long spigot which is internally reinforced, at the bottom, with a rigid plastic ring. Thanks to the length of its spigot, it is specifically suitable for an installation on industrial roofs.*

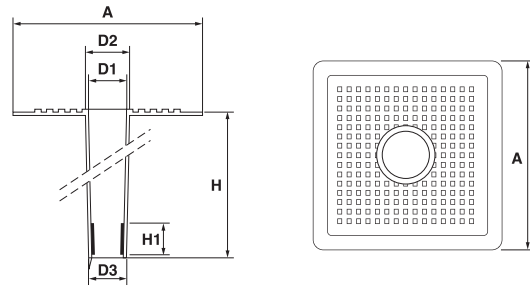

### BOCCHETTONE IN GOMMA EPDM CON CODOLO H 500 MM EPDM RUBBER ROOF DRAIN WITH A 500 MM SPIGOT

CODICE CODE	PER TUBI FOR PIPES	A	D1	D2	D3	H	H1	PAG LISTINO PRICE LIST PAGE	PZ 	PZ 
A021050080	Ø 80	320	80	88	80	500	12	9	12	192
A021050100	Ø 100	350	100	106	100	500	12	9	12	192
A021050120	Ø 120	370	127	133	120	500	12	9	12	96
A021050150	Ø 150	385	150	156	150	500	12	9	12	96

GOMMA  
RUBBER

MBP

GOMMA  
RUBBER

MBP



### Bocchettone sviluppato su richiesta per applicazioni speciali Roof drains specifically developed on request for special application

IT

Una serie di bocchettoni di scarico in gomma EPDM sviluppati su apposita richiesta per applicazioni speciali



EN

*A range of EPDM rubber roof drains specifically developed on request for special application*

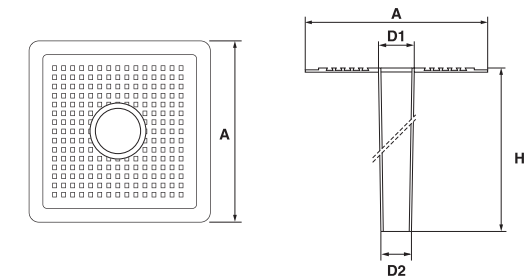

### BOCCHETTONE IN GOMMA EPDM Ø 60 MM CON CODOLO H 650 MM EPDM RUBBER ROOF DRAIN Ø 60 MM WITH H 650 MM SPIGOT

CODICE CODE	PER TUBI FOR PIPES	A	D1	D2	D3	H	H1	PAG LISTINO PRICE LIST PAGE	PZ 	PZ 
A100065060	Ø 63 - 75	310	62	59	-	650	-	9	20	160

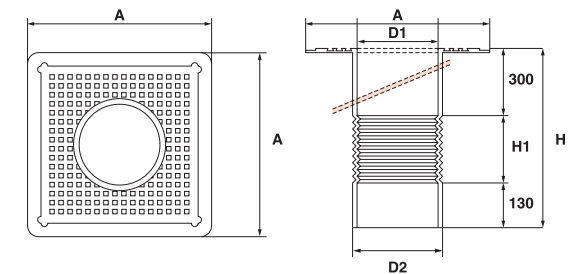

### BOCCHETTONE IN GOMMA EPDM Ø 140 MM CON CODOLO H 600 MM A SOFFIETTO EPDM RUBBER ROOF DRAIN Ø 140 MM WITH A 600 MM FLEXIBLE SPIGOT

CODICE CODE	PER TUBI FOR PIPES	A	D1	D2	D3	H	H1	PAG LISTINO PRICE LIST PAGE	PZ 	PZ 
A110065140	Ø 140	400	140	140	-	600	170	9	1	-



# BOCCHETTONI "GENIUS" IN TPE

ROOF DRAIN "GENIUS" MADE OF TPE



TPE

MBP



## DESCRIZIONE

### DESCRIPTION

- 1 Spigolo rinforzato  
*Reinforced edge*
- 2 Anelli circolari "a coda di rondine" per favorire l'aggancio del bitume fuso  
*"Dovetail" circular rings to facilitate the attachment of the cast bitumen*
- 3 Predisposizione per l'inserimento di parafoglia  
*Predisposed for the installation of a leaf-guard*
- 4 Fori passanti per favorire la perfetta fusione della membrana superiore con quella inferiore  
*Through-holes to facilitate the upper membrane's perfect fusion with the lower membrane*
- 5 Parte inferiore della flangia dotata di zigrinature  
*Knurled flange bottom*
- 6 Codolo H 250 mm e H 400 mm  
*250 mm H and 400 mm H spigot*
- 7 Coppie di alette "antiriflusso" spessore 1 cm  
*Two 1cm thick "backflow prevention" flaps*

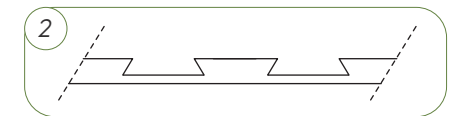

## VANTAGGI

### ADVANTAGES

- **Adattabile** a qualsiasi tipo di pluviale di scarico
- **Ampia gamma di misure** per tubi da Ø 63 a Ø 160
- **Alta resistenza alla fiamma**
- **Ampia flangia** con fori passanti
- **Adattabile** to any type of drainpipe
- **Wide range of sizes** for pipes of Ø 63 to Ø 160
- **Exceptional fire resistance**
- **Wide flange** with through holes

27

ETERNO IVICA • ETERNO

**Bocchettone "genius" in TPE con codolo h 250 mm e 400 mm**  
**"Genius" roof drain made of TPE with a 250 mm or 400 mm spigot**

IT

Realizzato con uno speciale compound di gomma termoplastica, resistente alle basse temperature (flessibilità a freddo =  $-40^{\circ}$ ), è compatibile con qualsiasi membrana a base di bitume. Il bocchettone "Genius" è dotato di un esclusivo settore circolare della flangia con fori passanti, che permettono la perfetta fusione tra la membrana bituminosa posta al di sopra della flangia con quella posta al di sotto. Il codolo è dotato di due o tre coppie di alette antiriflusso. Il prodotto è BREVETTATO.

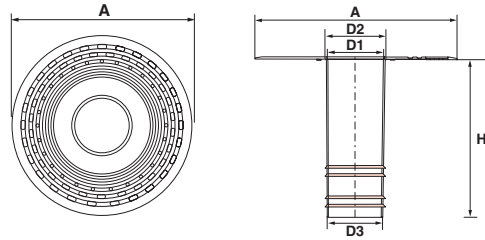

EN

Manufactured of a special compound of thermoplastic rubber, it is highly resistant against low temperatures (cold flexibility =  $-40^{\circ}$ ) as well as perfectly compatible with all sorts of bituminous waterproofing membrane. "Genius" is the only roof drain in the world with a special circular row of holes and through these holes the waterproofing membrane torched over its flange is totally blended with the membrane below. The spigot is provided with two or three couples of anti-infiltration tongues that prevent any infiltration. The product is PATENTED.

TPE

MBP



TPE

MBP

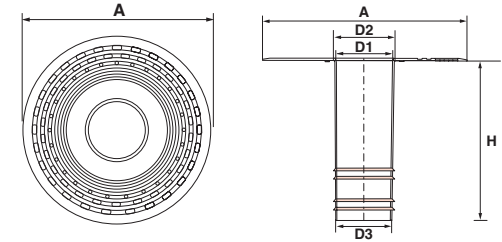

**BOCCHETTONE "GENIUS" IN TPE CON CODOLO H 400 MM**  
**"GENIUS" ROOF DRAIN MADE OF TPE WITH A 400 MM**

CODICE CODE	PER TUBI FOR PIPES	A	D1	D2	D3	H	PAG LISTINO PRICE LIST PAGE	PZ 	PZ 
A017040063	Ø 63	320	51	60	49	400	10	15	240
A017040075	Ø 75	320	63	70	62	400	10	15	240
A017040082	Ø 82	320	69	75	68	400	10	15	240
A017040090	Ø 90	320	80	84	79	400	10	15	240
A017040100	Ø 100	320	86	90	85	400	10	15	240
A017040110	Ø 110	380	95	101	94	400	10	12	192
A017040125	Ø 125	380	109	115	108	400	10	12	96
A017040140	Ø 140	380	128	134	127	400	10	10	80
A017040150	Ø 150	380	134	140	132	400	10	10	80
A017040160	Ø 160	380	140	146	139	400	10	10	80

**BOCCHETTONE "GENIUS" IN TPE CON CODOLO H 250 MM**  
**"GENIUS" ROOF DRAIN MADE OF TPE WITH A 250 MM**

CODICE CODE	PER TUBI FOR PIPES	A	D1	D2	D3	H	PAG LISTINO PRICE LIST PAGE	PZ 	PZ 
A017025063	Ø 63	320	51	60	49	250	10	25	400
A017025075	Ø 75	320	63	70	62	250	10	25	400
A017025082	Ø 82	320	69	75	68	250	10	25	400
A017025090	Ø 90	320	80	84	79	250	10	25	400
A017025100	Ø 100	320	86	90	85	250	10	25	400
A017025110	Ø 110	380	95	101	94	250	10	15	240
A017025125	Ø 125	380	109	115	108	250	10	15	240
A017025140	Ø 140	380	128	134	127	250	10	10	160
A017025150	Ø 150	380	134	140	132	250	10	10	160
A017025160	Ø 160	380	140	146	139	250	10	10	160



# BOCCHETTONI "EURO" IN TPE

"EURO" ROOF DRAIN MADE OF TPE



**Bocchettone "euro" in TPE con codolo h 250 mm e 400 mm**  
 "Euro" roof drain made of TPE with a 250 or 400 mm spigot

IT

Realizzato con uno speciale compound di gomma termoplastica, resistente alle basse temperature (flessibilità a freddo = -40°), è compatibile con qualsiasi membrana a base di bitume. La flangia è dotata di canali a "coda di rondine" e di una speciale zigrinatura che garantiscono l'aggancio delle membrane bituminose. Il codolo è dotato di due o tre coppie di alette antiriflusso, a seconda che sia lungo 250 mm o 400 mm.

EN

Manufactured of a special compound of thermoplastic rubber, it is highly resistant against low temperatures (cold flexibility = -40°) as well as perfectly compatible with all sorts of bituminous waterproofing membrane. The traditional dove-tail channels and special shagreens on the flange allow a perfect bond to the membrane. The spigot is provided with two or three couples of anti-infiltration tongues that prevent any infiltration between the spigot and the drain pipe.

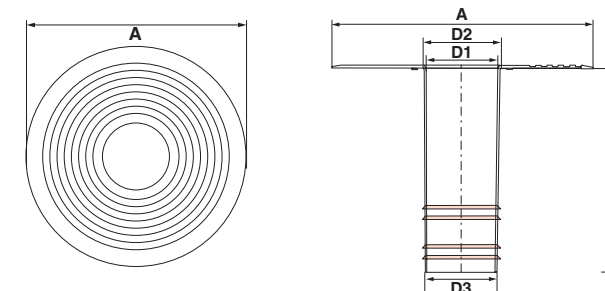

**BOCCHETTONE "EURO" IN TPE CON CODOLO H 250 MM**  
 "EURO" ROOF DRAIN MADE OF TPE WITH A 250 MM SPIGOT

CODICE CODE	PER TUBI FOR PIPES	A	D1	D2	D3	H	PAG LISTINO PRICE LIST PAGE	PZ 	PZ 
A013025063	Ø 63	320	51	60	49	250	11	25	400
A013025075	Ø 75	320	63	70	62	250	11	25	400
A013025082	Ø 82	320	69	75	68	250	11	25	400
A013025090	Ø 90	320	80	84	79	250	11	25	400
A013025100	Ø 100	320	86	90	85	250	11	25	400
A013025110	Ø 110	380	95	101	94	250	11	15	240
A013025125	Ø 125	380	109	115	108	250	11	15	240
A013025140	Ø 140	380	128	134	127	250	11	10	160
A013025150	Ø 150	380	134	140	132	250	11	10	160
A013025160	Ø 160	380	140	146	139	250	11	10	160

**BOCCHETTONE "EURO" IN TPE CON CODOLO H 400 MM**  
 "EURO" ROOF DRAIN MADE OF TPE WITH A 400 MM SPIGOT

CODICE CODE	PER TUBI FOR PIPES	A	D1	D2	D3	H	PAG LISTINO PRICE LIST PAGE	PZ 	PZ 
A013040063	Ø 63	320	51	60	49	400	11	15	240
A013040075	Ø 75	320	63	70	62	400	11	15	240
A013040082	Ø 82	320	69	75	68	400	11	15	240
A013040090	Ø 90	320	80	84	79	400	11	15	240
A013040100	Ø 100	320	86	90	85	400	11	15	240
A013040110	Ø 110	380	95	101	94	400	11	12	192
A013040125	Ø 125	380	109	115	108	400	11	12	96
A013040140	Ø 140	380	128	134	127	400	11	10	80
A013040150	Ø 150	380	134	140	132	400	11	10	80
A013040160	Ø 160	380	140	146	139	400	11	10	80



# BOCCHETTONI "MONDIAL" IN TPE

"MONDIAL" ROOF DRAIN MADE OF TPE

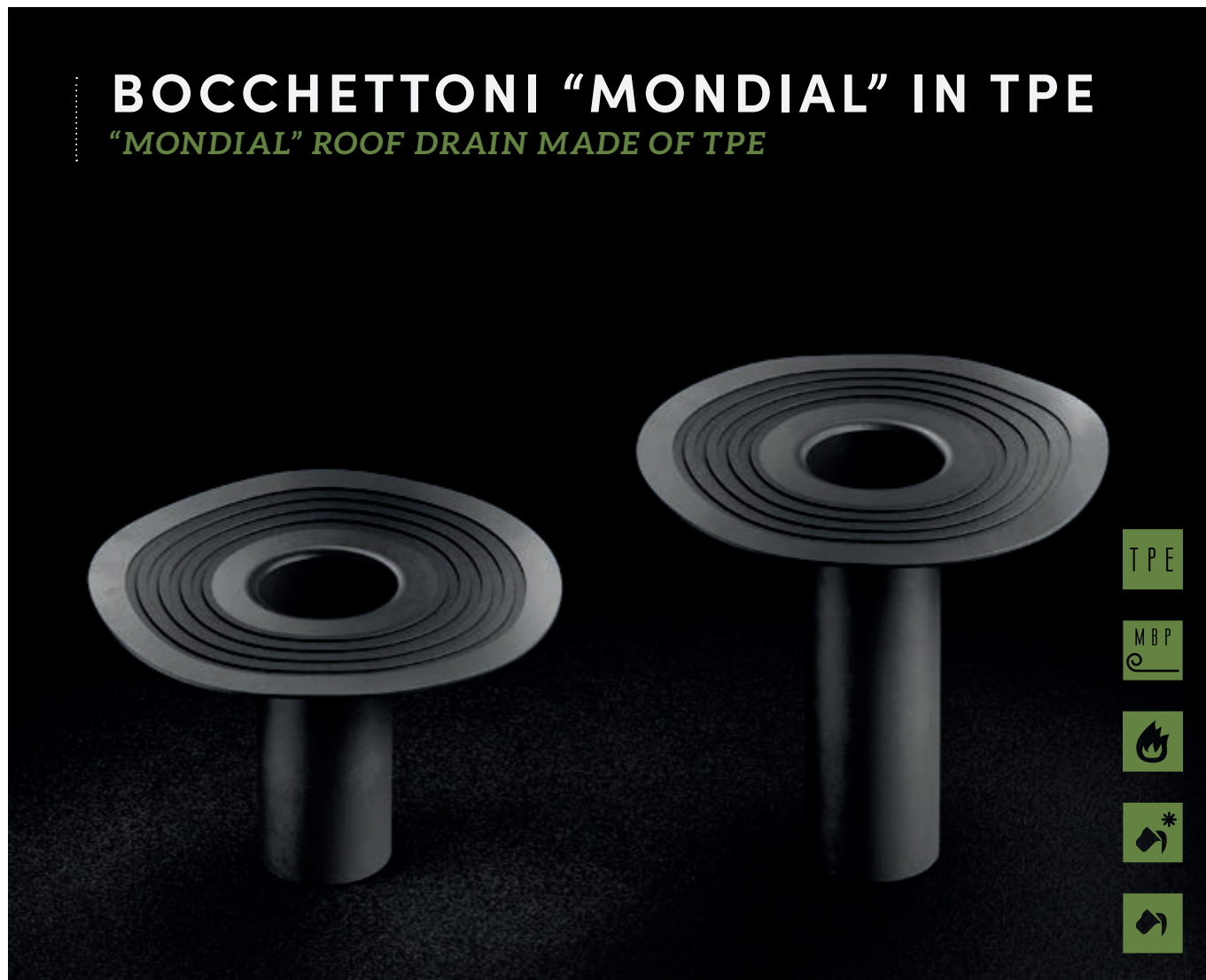

**Bocchettone "mondial" in TPE con codolo h 170 mm e 250 mm**  
 "Mondial" roof drain made of TPE with a 170 or 250 mm spigot

IT

Realizzato con uno speciale compound di gomma termoplastica, resistente alle basse temperature (flessibilità a freddo = -40°), è compatibile con qualsiasi membrana a base di bitume. La flangia è dotata di canali a "coda di rondine" e di una speciale zigrinatura che garantiscono l'aggancio delle membrane bituminose.

EN

Manufactured of a special compound of thermoplastic rubber, it is highly resistant against low temperatures (cold flexibility = -40°) as well as perfectly compatible with all sorts of bituminous waterproofing membrane. The traditional dove-tail channels and special shagreens on the flange allow a perfect bond to the membrane making the seal 100% effective.

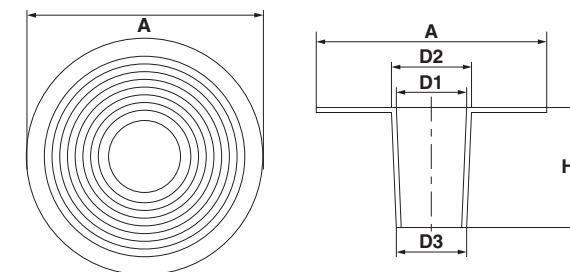

**BOCCHETTONE "MONDIAL" IN TPE CON CODOLO H 170 MM**  
 "MONDIAL" ROOF DRAIN MADE OF TPE WITH A 170 MM SPIGOT

CODICE CODE	PER TUBI FOR PIPES	A	D1	D2	D3	H	PAG LISTINO PRICE LIST PAGE	PZ 	PZ 
A010017060	Ø 60	265	52	56	49	170	12	25	625
A010017080	Ø 80	305	74	78	74	170	12	25	500
A010017100	Ø 100	335	93	97	89	170	12	25	400
A010017120	Ø 120	335	108	112	108	170	12	25	400
A010017150	Ø 150	365	137	141	137	170	12	10	200

**BOCCHETTONE "MONDIAL" IN TPE CON CODOLO H 250 MM**  
 "MONDIAL" ROOF DRAIN MADE OF TPE WITH A 250 MM SPIGOT

CODICE CODE	PER TUBI FOR PIPES	A	D1	D2	D3	H	PAG LISTINO PRICE LIST PAGE	PZ 	PZ 
A012025060	Ø 60	265	52	56	49	250	12	25	400
A012025080	Ø 80	305	74	78	74	250	12	25	400
A012025100	Ø 100	335	93	97	89	250	12	25	400
A012025120	Ø 120	335	108	112	108	250	12	15	240
A012025150	Ø 150	365	137	141	137	250	12	10	160

# BOCCHETTONI VERTICALI E LATERALI IN TPE

SIDE AND VERTICAL ROOF DRAIN MADE OF TPE



GOMMA  
RUBBER

MBP



## DESCRIZIONE

### DESCRIPTION

- ① Griglia in acciaio inox  
*Stainless steel grate*
- ② Telaio in acciaio inox  
*Stainless steel frame*
- ③ Valvola anti-intrusione Ø 50 / 75 / 82 / 90 / 100 \*  
*Anti-intrusion cap Ø 50 / 75 / 82 / 90 / 100 \**  
\* La valvola anti-intrusione dello scarico orizzontale è sempre Ø 100  
\* Anti-intrusion cap on side drain is always Ø 100
- ④ Prolunga  
*Extension element*
- ⑤ Scanalatura per il deflusso dell'acqua  
*Water drainage groove*
- ⑥ Scanalatura interna "acqua non stop"  
*"Non-stop water" internal groove*
- ⑦ Parte inferiore e superiore della flangia zigrinata  
*Top and bottom part of the knurled flange*
- ⑧ Flangia forata per una perfetta saldatura su qualsiasi sistema impermeabilizzante bituminoso  
*Flange perfectly compatible with any bituminous or resin waterproofing*
- ⑨ Bocchettone verticale Ø 50 / 75 / 82 / 90 / 100  
*Roof drain vertical Ø 50 / 75 / 82 / 90 / 100*
- ⑩ Bocchettone orizzontale Ø 50 / 75 / 90  
*Roof drain side Ø 50 / 75 / 90*
- ⑪ Fondo inclinato anti-ristagno d'acqua  
*Sloping bottom to prevent water stagnation*

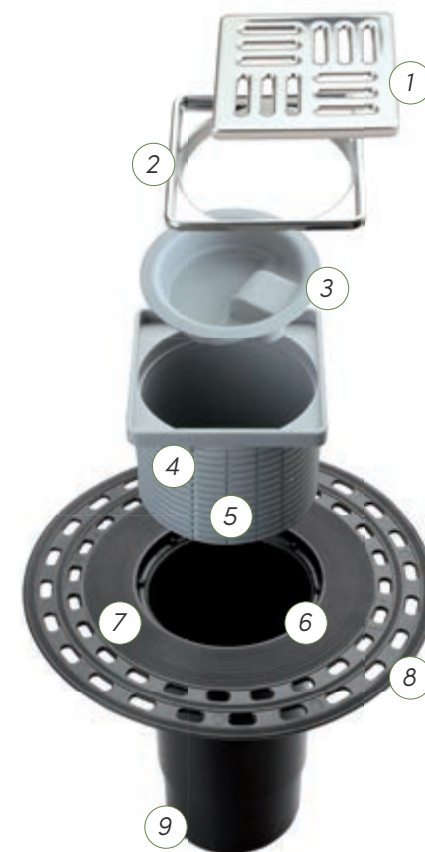

## VANTAGGI

### ADVANTAGES

- **Adattabile** a qualsiasi tipo di pluviale di scarico
- **Ampia gamma di misure** per tubi da Ø 50 a Ø 100
- **Alta resistenza alla fiamma**
- **Adattabile** a qualsiasi tipo di pluviale di scarico
- **Wide range of sizes** for pipes of Ø 50 to Ø 100
- **Exceptional fire resistance**

35

ETERNO IVICA • ETERNO



**Bocchettone con scarico laterale o verticale in TPE****TPE roof drain with side or vertical exit**

IT

I bocchettone in TPE sono la soluzione ideale per balconi e terrazze: la flangia forata permette la perfetta saldatura su qualsiasi sistema impermeabilizzante bituminoso o resinoso. Il sistema è integrato da una prolunga con griglia e telaio in acciaio inox, la cui altezza può essere facilmente modificata in base allo spessore del massetto, e da una speciale valvola anti-intrusione "senz'acqua". Gli elementi sono da ordinarsi separatamente.

EN

The TPE roof drain with side and vertical exit is the ideal solution for balconies and terraces: its flange with holes is perfectly compatible with any bituminous or resin waterproofing. System is composed by an extension element that can be adjusted according to concrete screed thickness, and by a stainless steel grate plus frame. A special anti-intrusion cap is also available on request. Elements to be ordered separately.

**VALVOLA ANTI-INTRUSIONE  
ANTI-INTRUSION CAP**

CODICE CODE	PER TUBI FOR PIPES	VALVOLA ANTI-INTRUSIONE ANTI-INTRUSION CAP	A	A1	H	D	PAG LISTINO PRICE LIST PAGE	PZ 	PZ 
A410010050	Ø 50	Ø 50	42,3	-	-	-	13	1	-
A410010075	Ø 75	Ø 75	66,0	-	-	-	13	1	-
A410010082	Ø 82	Ø 82	71,8	-	-	-	13	1	-
A410010090	Ø 90	Ø 90	80,5	-	-	-	13	1	-
A410010100	Ø 100	Ø 100	89,8	-	-	-	13	1	-

**PROLUNGA E GRIGLIA  
EXTENTION AND GRATING**

CODICE CODE	PER TUBI FOR PIPES	A	H	PAG LISTINO PRICE LIST PAGE	PZ 	PZ 
A420100078	Prolunga H 90 / Extention element H 90	99	88	13	1	-
A420100037	Prolunga H 50 / Extention element H 50	99	48	13	1	-
A420100018	Prolunga H 18 / Extention element H 18	99	17,5	13	1	-
A430100100	Griglia con telaio / Grating with frame	104	5	13	1	-

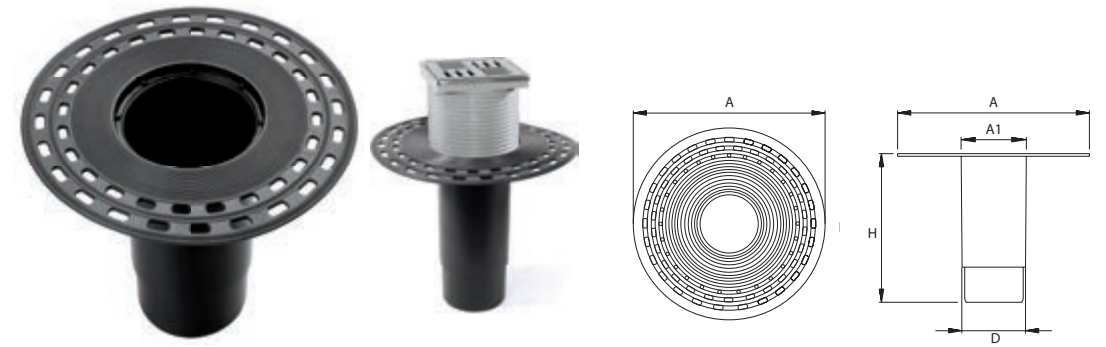
**BOCCHETTONE VERTICALE  
ROOF DRAIN VERTICAL**

CODICE CODE	PER TUBI FOR PIPES	VALVOLA ANTI-INTRUSIONE ANTI-INTRUSION CAP	A	A1	H	D	PAG LISTINO PRICE LIST PAGE	PZ 	PZ 
A201002050	Ø 50	Ø 50	230	43,3	200	42	13	9	-
A201002075	Ø 75	Ø 75	230	70,7	200	69,9	13	9	-
A201002082	Ø 82	Ø 82	230	76,8	200	75,5	13	9	-
A201002090	Ø 90	Ø 90	230	85,4	200	83,9	13	9	-
A201002100	Ø 100	Ø 100	230	95	200	94	13	9	-

**BOCCHETTONE LATERALE  
ROOF DRAIN SIDE**

CODICE CODE	PER TUBI FOR PIPES	VALVOLA ANTI-INTRUSIONE ANTI-INTRUSION CAP	A	A1	H	D	PAG LISTINO PRICE LIST PAGE	PZ 	PZ 
A201001050	Ø 50	Ø 100	230	89,9	70	49,5	13	18	-
A201001070	Ø 75	Ø 100	230	89,9	90	73,1	13	18	-
A201001090	Ø 90	Ø 100	230	89,9	120	88,6	13	18	-



# BOCCHETTONI ANGOLARI IN TPE

## TPE ANGULAR DRAINS



TPE

MBP



# BOCCHETTONE ANGOLARI IN TPE

## TPE ANGULAR DRAINS

IT

I Bocchettoni angolari in TPE, utilizzabili in qualsiasi condizione climatica, garantiscono una eccellente resistenza alla fiamma e alle basse temperature (-40°C).

Queste caratteristiche, unite alla semplicità della posa in opera, rendono questi articoli economici pur mantenendo standard qualitativi molto alti. Caratterizzati da un'ampia flangia e disponibili in diverse sezioni e lunghezze di cordolo, rappresentano un dettaglio fondamentale per la corretta canalizzazione e deflusso delle acque meteoriche su terrazze e balconi, assicurando una saldatura perfetta su qualsiasi sistema impermeabilizzante bituminoso o resinoso.

EN

Angular TPE roof drains are usable in any climate and they provide both excellent fire and low temperature resistance (-40°C). These features, combined with the simplicity of installation, make these items an economic solution while maintaining very high standards. Characterized by a wide flange and available in different sections and lengths of exit, they represent a crucial detail for the correct water drainage on terraces and balconies, ensuring perfect welding on any bituminous waterproofing system.



BOCCHETTONE ANGOLARE ANGOLO 90°  
SEZIONE TONDA DA Ø 63 mm a Ø 125 mm  
ANGULAR DRAIN 90° WITH ROUND SPIGOT  
from Ø 63 mm to Ø 125 mm



BOCCHETTONE ANGOLARE ANGOLO 90°  
per POGGIOLI SEZIONE 57x78 mm  
ANGULAR DRAIN 90° FOR BALCONIES  
57x78 mm SECTION



BOCCHETTONE ANGOLARE ANGOLO 90°  
per POGGIOLI SEZIONE 57x48 mm  
ANGULAR DRAIN 90° FOR BALCONIES  
57x48 mm SECTION



BOCCHETTONE ANGOLARE  
ANGOLO 45°  
SEZIONE 100 X 100 mm  
ANGULAR DRAIN 45°  
100x100 mm SECTION



BOCCHETTONE  
ANGOLARE ANGOLO 45°  
SEZIONE 100 X 65 mm  
ANGULAR DRAIN 45°  
100x65 mm SECTION



BOCCHETTONE  
ANGOLARE ANGOLO 90°  
SEZIONE 100 X 65 mm  
ANGULAR DRAIN 90°  
100x65 mm SECTION



BOCCHETTONE  
ANGOLARE ANGOLO 90°  
SEZIONE 100 X 100 mm  
ANGULAR DRAIN 90°  
100x100 mm SECTION

## DESCRIZIONE

## DESCRIPTION

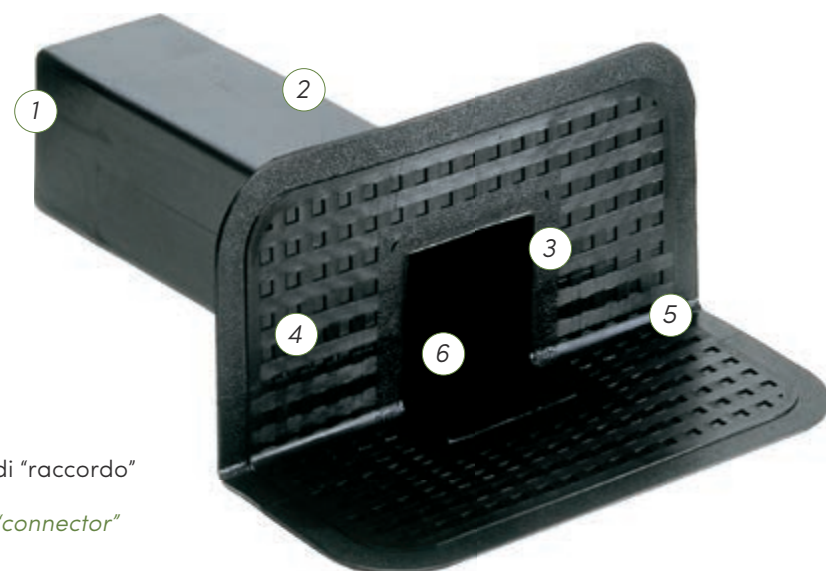

- ① Predisposizione per l'inserimento di "raccordo"  
*Predisposed for the insertion of a "connector"*
- ② Lunghezza codolo da 370 mm a 500 mm  
*Shank lenght from 370 mm to 500 mm*
- ③ Spigolo rinforzato  
*Reinforced edge*
- ④ Bassorilievi "a coda di rondine" per favorire l'aggancio del bitume fuso  
*"Dovetail" bas-relief to facilitate the attachment of the cast bitumen*
- ⑤ Angolo a 90° raggato  
*Radiused 90° corner element*
- ⑥ Predisposizione per l'inserimento di parafoglia  
*Predisposed for the installation of a leaf-guard*

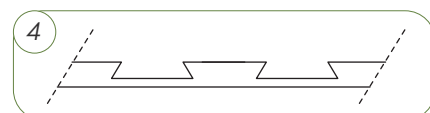

## VANTAGGI

## ADVANTAGES

IT

- Alta resistenza alla fiamma
- Ampia flangia
- Disponibile in diverse sezioni e lunghezze  
codolo

EN

- Exceptional fire resistance
- Wide flange
- Available in various cross-sections and  
shank lengths





**Bocchettone angolare in TPE - raccordi per bocchettone angolare**

*TPE angular drains - pipe adaptors for angular drain*

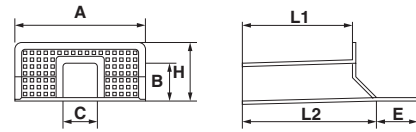
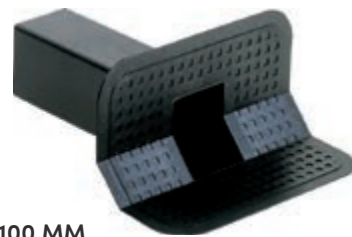

**SEZIONE 100X100 MM**  
100X100 MM SECTION

CODICE CODE	TIPO TYPE	A	B	C	E	H	L1	L2	PAG LISTINO PRICE LIST PAGE	PZ	PZ
A040415010	45°	340	92	92	105	168	375	415	14	5	80

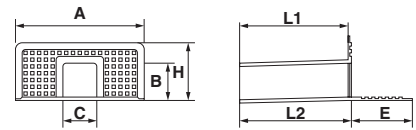

**SEZIONE 100X100 MM**  
100X100 MM SECTION

CODICE CODE	TIPO TYPE	A	B	C	E	H	L1	L2	PAG LISTINO PRICE LIST PAGE	PZ	PZ
A041375010	90°	340	92	92	145	168	375	375	14	5	80

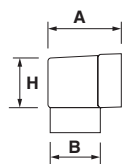

**RACCORDO SEZIONE 100X100 MM**  
PIPE ADAPTOR 100X100 MM SECTION

CODICE CODE	TIPO TYPE	A	B	H	PAG LISTINO PRICE LIST PAGE	PZ	PZ
F071080010	Ø 80	148	78	95	14	10	700
F071100010	Ø 100	148	78	95	14	10	700

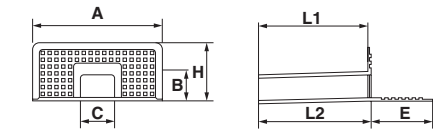

**SEZIONE 100X65 MM**  
65X100 MM SECTION

CODICE CODE	TIPO TYPE	A	B	C	E	H	L1	L2	PAG LISTINO PRICE LIST PAGE	PZ	PZ
A042425065	90°	340	62	92	145	168	425	425	14	10	140

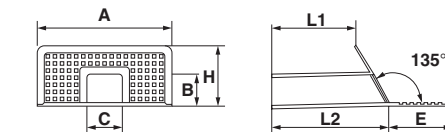

**SEZIONE 100X65 MM**  
65X100 MM SECTION

CODICE CODE	TIPO TYPE	A	B	C	E	H	L1	L2	PAG LISTINO PRICE LIST PAGE	PZ	PZ
A040425065	135°	340	62	95	145	115	370	425	14	10	140

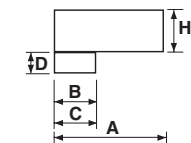

**RACCORDO SEZIONE 100X65 MM**  
PIPE ADAPTOR 100X65 MM SECTION

CODICE CODE	TIPO TYPE	A	B	C	D	H	PAG LISTINO PRICE LIST PAGE	PZ	PZ
F072063080	Ø 63 - 80	218	63	80	45	65	14	10	360
F072080100	Ø 80 - 100	218	80	100	65	65	14	10	360





**Bocchettone angolare in TPE con codolo tondo L 500 mm**  
**TPE angular drain with round spigot L 500 mm**

IT

Il bocchettone angolare con uscita tonda è provvisto di un codolo di scarico L 500 mm e può essere facilmente prolungato raccordandolo ad un normale tubo di plastica.

EN

The angular roof drain with round exit spigot is provided with a 500 mm long drain spigot which could be easily made longer simply by using a standard plastic pipe.

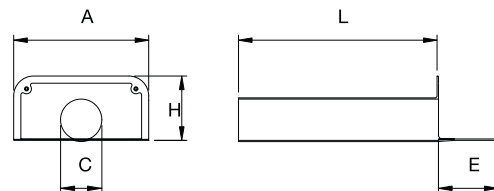

**BOCCHETTONE ANGOLARE USCITA TONDA L 500 MM**  
**ANGULAR DRAIN WITH ROUND SPIGOT L 500 MM**

CODICE CODE	PER TUBI FOR PIPES	A	C	E	H	L	PAG LISTINO PRICE LIST PAGE	PZ	PZ
A04550063	Ø 50	340	63	150	133	500	14	8	80
A04550075	Ø 75	340	75	150	133	500	14	8	80
A04550080	Ø 80	340	80	150	133	500	14	8	80
A04550090	Ø 90	340	90	150	165	500	14	8	80
A04550100	Ø 100	340	100	150	165	500	14	8	80
A04550110	Ø 110	340	110	150	165	500	14	8	80
A04550125	Ø 125	340	125	150	185	500	14	7	70



**Bocchettone angolare per poggioli**  
**Angular drain for balconies**

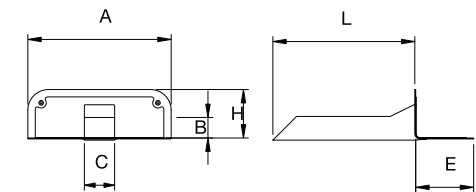

**BOCCHETTONE ANGOLARE PER POGGIOLI SEZIONE 57 X 78 MM**  
**ANGULAR DRAIN FOR BALCONIES 57 X 78 MM SECTION**

CODICE CODE	COLORE COLOUR	A	B	C	E	H	L	PAG LISTINO PRICE LIST PAGE	PZ	PZ
A043347001	Avorio White	348	57	78	140	120	347	15	5	140
A043347002	Rosso Brick-red	348	57	78	140	120	347	15	5	140
A043347003	Rame Copper	348	57	78	140	120	347	15	5	140
A043347004	Nero Black	348	57	78	140	120	347	15	5	140

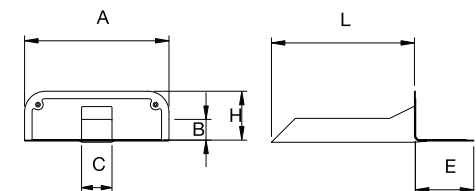
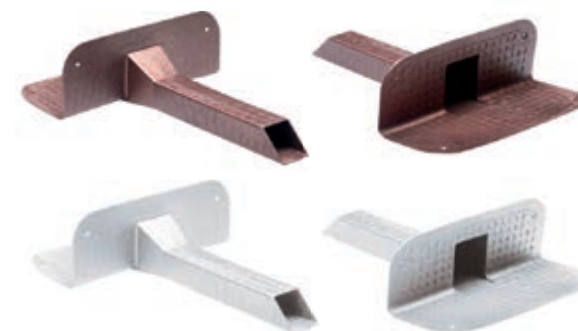

**BOCCHETTONE ANGOLARE PER POGGIOLI SEZIONE 57 X 48 MM**  
**ANGULAR DRAIN FOR BALCONIES 57 X 48 MM SECTION**

CODICE CODE	COLORE COLOUR	A	B	C	E	H	L	PAG LISTINO PRICE LIST PAGE	PZ	PZ
A043347101	Avorio White	348	48	57	140	120	347	15	5	140
A043347102	Rosso Brick-red	348	48	57	140	120	347	15	5	140
A043347103	Rame Copper	348	48	57	140	120	347	15	5	140
A043347104	Nero Black	348	48	57	140	120	347	15	5	140

# ESALATORI IN TPE

TPE ROOF VENTS



TPE

MBP



# ESALATORE IN TPE PER MEMBRANE IN BITUME POLIMERO

## TPE ROOF VENTS FOR BITUMINOUS MEMBRANES

IT

Gli esalatori in TPE sono accessori indispensabili per assicurare la fuoriuscita del vapore acqueo che si accumula al di sotto dello strato impermeabile in bitume polimero; questo importante accorgimento elimina il rischio di pericolosi rigonfiamenti del manto impermeabile che causano il distacco dell'impermeabilizzazione dal supporto o dal piano di posa.

In tal modo i solai si mantengono asciutti e le guaine acquisiscono longevità con estrema garanzia delle loro performance.

EN

The TPE vents accessories are needed to ensure the vapor to escape from below the waterproofing bituminous membrane. This important device eliminates the risk of dangerous swelling and detachment from the subfloor of the waterproofing membrane.

In this way the structure is kept dry and waterproofing acquires extreme longevity with higher guarantee of its performance.

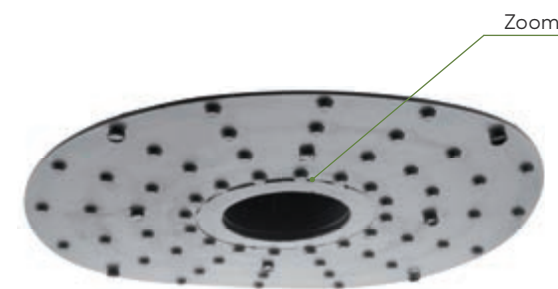

Speciali punti di appoggio in rilievo, a contatto con il piano di posa studiati per consentire il passaggio del vapore  
Special embossed supporting points, in contact with the base designed to let steam pass



ESALATORE SEMPLICE E DOPPIO  
DA H 225 mm a H 400 mm  
SIMPLE AND DOUBLE WALL ROOF VENTS  
H 225 TO 400 mm



ESALATORE "MAXI"  
SEMPLICE E DOPPIO H 270 mm  
SIMPLE AND DOUBLE WALL "MAXI" ROOF  
VENT H 270 mm



ESALATORE COIBENTATO  
SEMPLICE E DOPPIO H 225 mm  
INSULATED SIMPLE AND DOUBLE  
WALL ROOF VENTS H 225 mm

47

ETERNO IVICA • ETERNO

## DESCRIZIONE

## DESCRIPTION

- ① Cupola rinforzata  
*Reinforced dome*

---

- ② Protezione circolare  
*Protection collar*

---

- ③ Speciale zigrinatura per favorire l'aggancio del bitume fuso  
*Special ribbing to facilitate the attachment of the cast bitumen*

---

- ④ Punti di ancoraggio per il bitume fuso  
*Anchoring points for the cast bitumen*



## VANTAGGI

## ADVANTAGES

IT

- Ampia gamma di misure per tubi da Ø 50 a Ø 100
- Alta resistenza alla fiamma

EN

- *Wide range of sizes for pipes of Ø 50 to Ø 100*
- *Exceptional fire resistance*

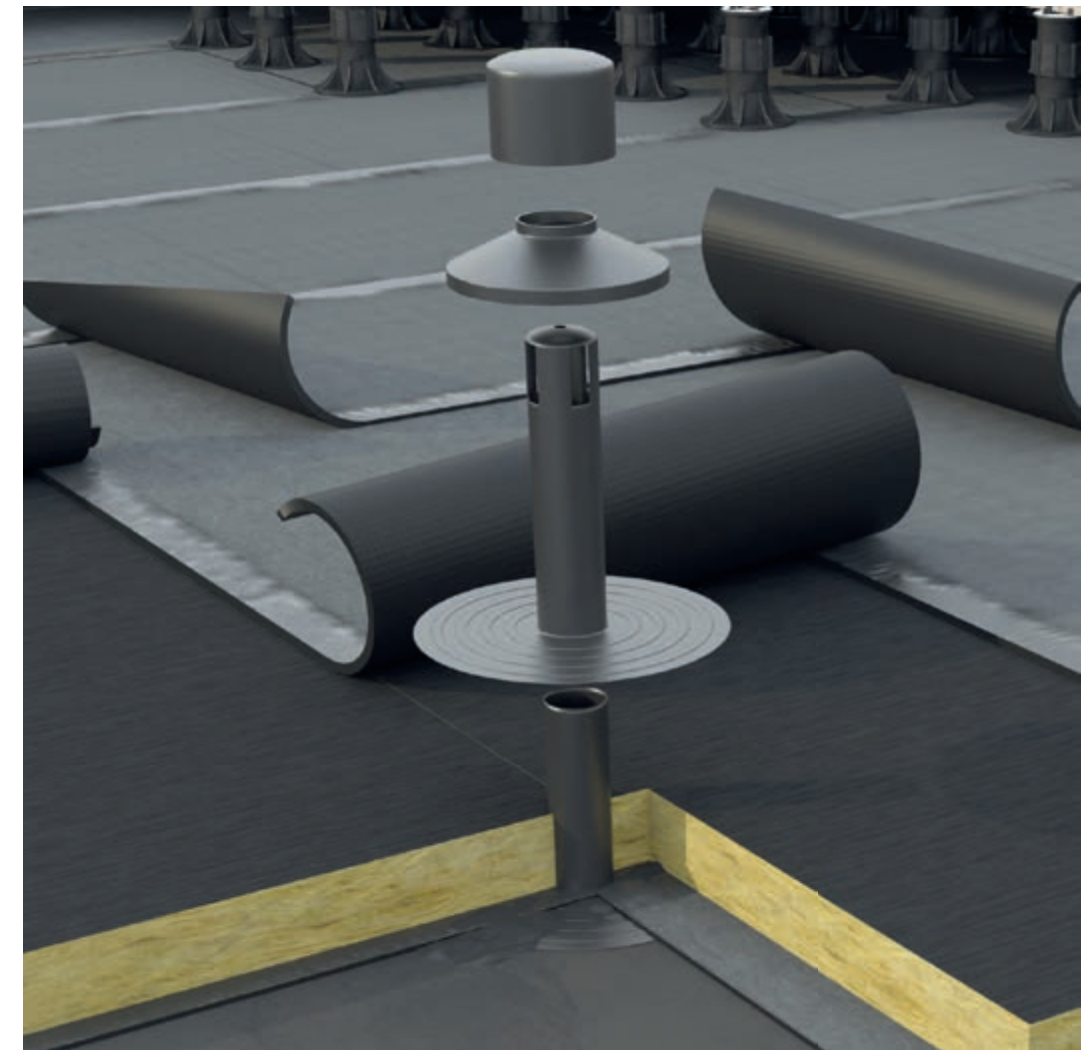



## Esalatore in TPE semplice e doppio - protezione circolare

### Simple wall and double wall TPE roof vents - protection collar

IT

La funzione dell'esalatore è quella di permettere la fuoriuscita del vapore che si crea al di sotto della membrana impermeabile. Viene realizzato in due modelli: il tipo "semplice" che si usa in presenza della sola membrana impermeabile ed il tipo "doppio" che si usa in presenza di pannello isolante. Raccomandiamo sempre l'utilizzo dell'apposita protezione circolare.

EN

The vent pipe allows moisture and vapour under waterproofing membrane to go out. It is available in the following models: the simple wall version used in case of a simple waterproofing membrane and the double wall version used in the presence of insulating panels. For a further protection, the use of the special protection collar is also recommended.



**SEMPLICE H 225/270 MM**  
SIMPLE WALL H 225/270 MM

CODICE CODE	ESTERNO EXTERNAL	A	B	H	H1	PAG LISTINO PRICE LIST PAGE	PZ PZ	PZ PZ
D011225060	Ø 62	60	300	225	-	16	30	270
D011225075	Ø 75	72	300	225	-	16	25	270
D014270075	Ø 75	72	300	270	-	16	25	270

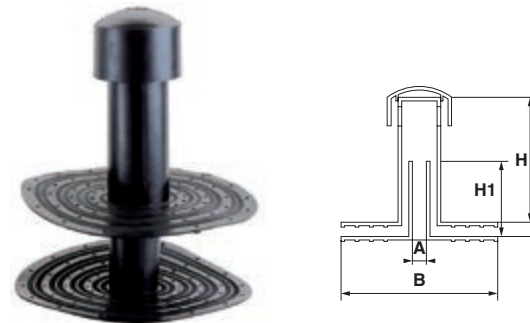

**DOPPIO H 225/270 MM**  
DOUBLE WALL H 225/270 MM

CODICE CODE	TIPO TYPE	A	B	H	H1	PAG LISTINO PRICE LIST PAGE	PZ PZ	PZ PZ
D030225075	Ø 75	60	300	225	190	16	25	225
D030270075	Ø 75	60	300	270	190	16	25	225

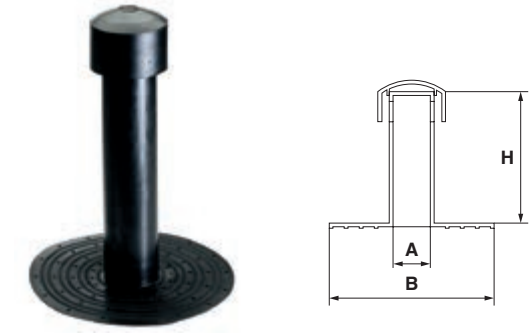

**SEMPLICE H 400 MM**  
SIMPLE WALL H 400 MM

CODICE CODE	ESTERNO EXTERNAL	A	B	H	H1	PAG LISTINO PRICE LIST PAGE	PZ PZ	PZ PZ
D011400075	Ø 75	72	300	400	-	16	25	200

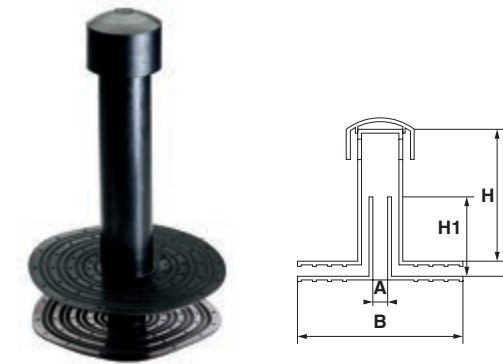

**DOPPIO H 400MM**  
DOUBLE WALL H 400 MM

CODICE CODE	ESTERNO EXTERNAL	A	B	H	H1	PAG LISTINO PRICE LIST PAGE	PZ PZ	PZ PZ
D030400075	Ø 75	60	300	400	190	16	25	200



**PROTEZIONE CIRCOLARE**  
PROTECTION COLLAR

CODICE CODE	ESTERNO EXTERNAL	A	B	H	PAG LISTINO PRICE LIST PAGE	PZ PZ	PZ PZ
D150000000	-	72	180	60	16	25	200

### Esalatore "maxi" in TPE semplice e doppio Simple wall and double wall TPE "maxi" roof vent

IT

L'esalatore "Maxi" è realizzato in due modelli: il tipo "semplice" che si usa in presenza della sola membrana impermeabile, il tipo "doppio" che si usa in presenza di un pannello isolante. Raccomandiamo sempre l'utilizzo dell'apposita protezione circolare.

EN

The "Maxi" type vent pipe is also available in two different versions, the simple wall version used in case of a simple waterproofing membrane and a double wall version used in the presence of insulating boards. For a further protection, the use of the special protection collar is also recommended.

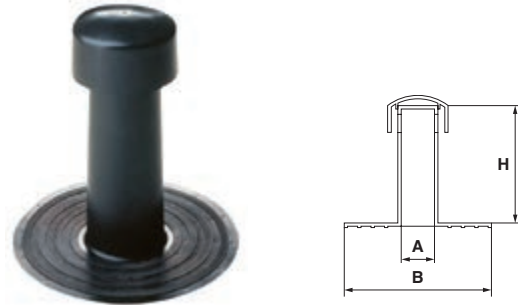

"MAXI" SEMPLICE H 270 MM  
SIMPLE WALL "MAXI" SIMPLE WALL H 270 MM

CODICE CODE	TIPO TYPE	A	B	H	PAG LISTINO PRICE LIST PAGE	PZ 	PZ 
D015270110	Ø 105	100	300	270	17	20	180

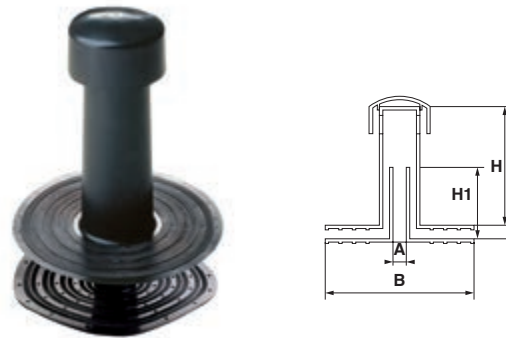

"MAXI" DOPPIO H 270 MM  
"MAXI" DOUBLE WALL H 270 MM

CODICE CODE	ESTERNO EXTERNAL	A	B	H	H1	PAG LISTINO PRICE LIST PAGE	PZ 	PZ 
D033270110	Ø 105	60	300	270	190	17	20	180

TPE

MBP



TPE

MBP



### Esalatore in TPE coibentato semplice e doppio - protezione circolare Insulated simple wall and double wall TPE roof vent - protection collar

IT

L'esalatore coibentato, grazie alla coibentazione in polistirolo presente nella parete esterna, elimina il rischio di condensa dovuto alla differenza di temperatura fra l'ambiente interno ed esterno. Anche l'esalatore coibentato è disponibile nei modelli "semplice" e "doppio" ed è completato dalla protezione circolare.

EN

Thanks to the internal polystyrene insulation body, which allows the moisture to get out through the dome more easily, this type of vent pipe eliminates any risk of condensation due to the difference in temperature between the outside and the inside. Available in the "simple" and "double wall" versions with a proper protection collar.

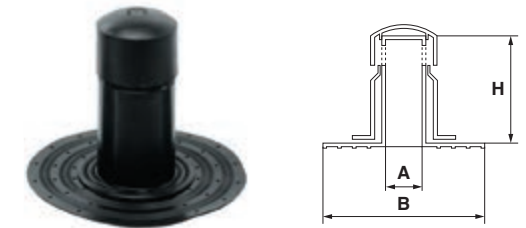

COIBENTATO SEMPLICE H 225 MM  
INSULATED SIMPLE WALL H 225 MM

CODICE CODE	ESTERNO EXTERNAL	A	B	H	PAG LISTINO PRICE LIST PAGE	PZ 	PZ 
D040225075	Ø 105	70	300	225	17	20	180

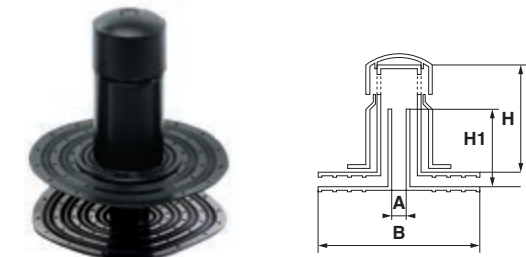

COIBENTATO DOPPIO H 225 MM  
INSULATED DOUBLE WALL H 225 MM

CODICE CODE	ESTERNO EXTERNAL	A	B	H	H1	PAG LISTINO PRICE LIST PAGE	PZ 	PZ 
D050225075	Ø 105	60	300	225	190	17	20	180



PROTEZIONE CIRCOLARE  
PROTECTION COLLAR

CODICE CODE	ESTERNO EXTERNAL	A	B	H	PAG LISTINO PRICE LIST PAGE	PZ 	PZ 
D160000000	-	105	205	60	17	20	1400

# RACCORDI PER TUBI IN TPE E IN GOMMA EPDM RACCORDO CONICO IN TPE

EPDM RUBBER AND TPE BASE FITTINGS FOR PIPES  
TPE CONICAL BASE FITTING FOR PIPES

TPE

MBP

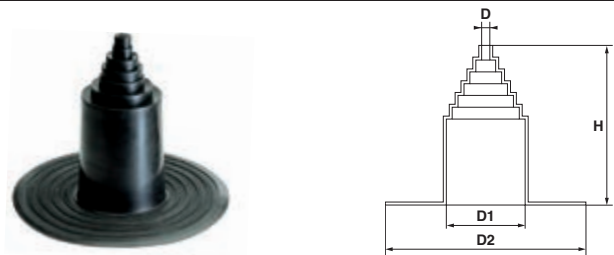

RACCORDO IN GOMMA EPDM  
EPDM RUBBER BASE FITTING

CODICE CODE	TIPO TYPE	D	D1	D2	H	PAG LISTINO PRICE LIST PAGE	PZ 	PZ 
F004000000	Gomma EPDM EPDM Rubber	15	130	330	250	18	15	240



RACCORDO IN TPE  
TPE BASE FITTING

CODICE CODE	TIPO TYPE	D	D1	D2	H	PAG LISTINO PRICE LIST PAGE	PZ 	PZ 
F001000000	TPE TPE	40	175	395	190	18	12	360



RACCORDO CONICO IN TPE  
TPE CONICAL BASE FITTING

CODICE CODE	TIPO TYPE	D	D1	D2	H	PAG LISTINO PRICE LIST PAGE	PZ 	PZ 
F013000000	TPE TPE	15	55	210	120	18	50	2100

# ANGOLI IN TPE TPE CORNERS

TPE

MBP



ANGOLO INTERNO "MEDIO"  
INTERNAL CORNER "MEDIUM"

CODICE CODE	A	B	H	PAG LISTINO PRICE LIST PAGE	PZ 	PZ 
F011001100	95	-	95	18	200	6000 *

\* Dimensioni pallet: mm 1200 x 800 x h 1100

\* Pallet size: mm 1200 x 800 x h 1100

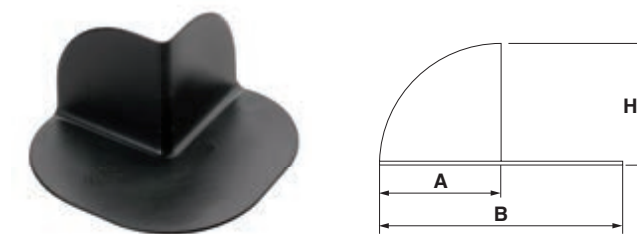

ANGOLO ESTERNO "MEDIO"  
EXTERNAL CORNER "MEDIUM"

CODICE CODE	A	B	H	PAG LISTINO PRICE LIST PAGE	PZ 	PZ 
F010001100	93	173	100	18	100	3000 *

\* Dimensioni pallet: mm 1200 x 800 x h 1100

\* Pallet size: mm 1200 x 800 x h 1100



# ACCESSORI PER MEMBRANE SINTETICHE IN PVC

## ACCESSORIES FOR PVC SYNTHETIC MEMBRANES



IT

Una linea completa di accessori interamente costruiti in materiale sintetico che per le sue caratteristiche di efficacia, resistenza e durata sta diventando sempre più richiesto nelle impermeabilizzazioni.

Tutti elementi progettati, realizzati e testati dagli specialisti delle coperture impermeabili.

Gli accessori Eterno Ivica in materiale sintetico possono essere utilizzati in tutte le coperture piane: a tetto sia caldo sia rovescio, zavorrate e non zavorrate.

EN

*A complete line of accessories made entirely from synthetic material. Thanks to its effectiveness, strength and durability, is becoming increasingly used as a waterproofing material.*

*All the elements are designed, manufactured and tested by specialists in the field of waterproof roofing.*

*Eterno Ivica's accessories can be used for all types of flat roofing applications: whether hot, reverse, ballasted or non-ballasted.*

BOCCHETTONI "EURO" IN PVC  
*"EURO" PVC DRAIN*

BOCCHETTONI ANGOLARI IN PVC  
*PVC ANGULAR DRAINS*

ESALATORI IN PVC SEMPLICI E DOPPI  
*SIMPLE WALL AND DOUBLE WALL PVC ROOF VENTS*

ANGOLI IN PVC  
*PVC CORNER*

RACCORDI IN PVC  
*PVC BASE FITTING*

PROFILI PERIMETRALI IN PVC  
*PVC PROFILES*

# BOCCHETTONI "EURO" IN PVC

"EURO" PVC DRAIN



PVC

PVC

SSS

## DESCRIZIONE

### DESCRIPTION

- 1 Predisposizione per l'inserimento di parafoglie  
*Predisposed for the installation of leaf-guards*
- 2 Alta resistenza alle basse temperature  
*Exceptional resistance to low temperatures*
- 3 Codolo h 250 e 400 mm  
*250 mm and 400 mm H spigot*
- 4 Coppie di speciali alette antireflusso spessore 10 mm  
*Two special backflow prevention flaps thickness 10 mm*



## VANTAGGI

### ADVANTAGES

- **Adattabile** a qualsiasi tipo di pluviale di scarico
- **Ampia gamma di misure**  
da Ø 63 mm a Ø 160 mm
- **Ampia flangia**
- Codolo con **alette antireflusso**
- **Adattabile** to any type of drainpipe
- **Wide range of sizes**  
from Ø 63 mm to Ø 160 mm
- **Wide flange**
- Spigot provided **with anti-infiltration tongues**



59

ETERNO IVICA • ETERNO

## Bocchettone "euro" in PVC con codolo h 250 mm e 400 mm

### "Euro" PVC roof drain with a 250 or 400 mm spigot

IT

Realizzati in PVC, resistenti alle basse temperature (flessibilità a freddo = -40°), sono compatibili con qualsiasi membrana impermeabile in PVC. La flangia è liscia, in modo da consentire una perfetta fusione con le membrane impermeabili. Il codolo è dotato di due o tre coppie di alette antiriflusso, a seconda che sia lungo 250 mm o 400 mm.

EN

Manufactured of PVC, it is highly resistant against low temperatures (cold flexibility = -40°) as well as perfectly compatible with any sort of PVC membrane. The flange is totally smooth for a perfect bonding to the waterproofing sheet. According to the length of 250 or 400 mm, the spigot is provided with two or three couples of anti-infiltration rings.

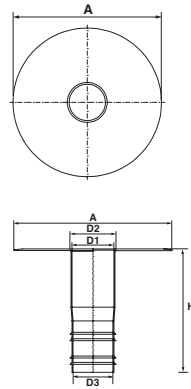

### BOCCHETTONE H 250 MM

#### ROOF DRAIN H 250 MM

CODICE CODE	PER TUBI FOR PIPES	A	D1	D2	D3	H	PAG LISTINO PRICE LIST PAGE	PZ 	PZ 
A014025063	Ø 63	320	51	60	49	250	22	15	240
A014025075	Ø 75	320	63	70	62	250	22	15	240
A010017100	Ø 82	320	69	75	68	250	22	15	240
A014025090	Ø 90	320	80	84	79	250	22	15	240
A014025100	Ø 100	320	86	90	85	250	22	15	240
A014025110	Ø 110	380	95	101	94	250	22	15	240
A014025125	Ø 125	380	109	115	108	250	22	15	240
A014025140	Ø 140	380	128	134	127	250	22	10	160
A014025150	Ø 150	380	134	140	132	250	22	10	160
A014025160	Ø 160	380	140	146	139	250	22	8	128

PVC

PVC

SSS

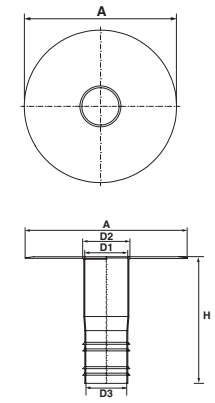

### BOCCHETTONE H 400 MM

#### ROOF DRAIN H 400 MM

CODICE CODE	PER TUBI FOR PIPES	A	D1	D2	D3	H	PAG LISTINO PRICE LIST PAGE	PZ 	PZ 
A014040063	Ø 63	320	51	60	49	400	22	15	240
A014040075	Ø 75	320	63	70	62	400	22	15	240
A014040082	Ø 82	320	69	75	68	400	22	15	240
A014040090	Ø 90	320	80	84	79	400	22	15	240
A014040100	Ø 100	320	86	90	85	400	22	8	128
A014040110	Ø 110	380	95	101	94	400	22	8	128
A014040125	Ø 125	380	109	115	108	400	22	8	128
A014040140	Ø 140	380	128	134	127	400	22	4	64
A014040150	Ø 150	380	134	140	132	400	22	4	64
A014040160	Ø 160	380	140	146	139	400	22	4	64



PRODOTTO PER MEMBRANE  
SINTETICHE IN PVC  
PRODUCTS FOR PVC SYNTHETIC  
MEMBRANES



PRODOTTO PER MEMBRANE  
SINTETICHE IN PVC  
PRODUCTS FOR PVC SYNTHETIC  
MEMBRANES



# BOCCHETTONI ANGOLARI IN PVC

## PVC ANGULAR DRAINS

PVC

PVC

SSS

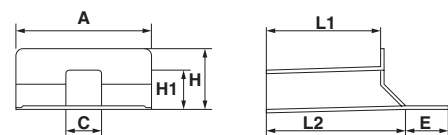

SEZIONE 100 X 100 MM  
100 X 100 MM SECTION

CODICE CODE	TIPO TYPE	MISURA SIZE	A	C	E	H	H1	L1	L2	PAG LISTINO PRICE LIST PAGE	PZ	PZ
A060415010	45°	45°	340	92	105	168	92	375	415	23	5	80

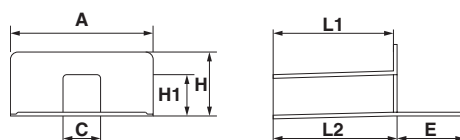
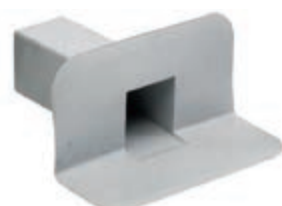

SEZIONE 100 X 100 MM  
100 X 100 MM SECTION

CODICE CODE	TIPO TYPE	MISURA SIZE	A	C	E	H	H1	L1	L2	PAG LISTINO PRICE LIST PAGE	PZ	PZ
A061375010	90°	90°	340	92	145	168	92	375	375	23	5	80

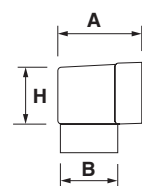

RACCORDO SEZIONE 100 X 100 MM  
PIPE ADAPTOR 100 X 100 MM SECTION

CODICE CODE	MISURA SIZE	A	B	H	PAG LISTINO PRICE LIST PAGE	PZ	PZ
F071080010	Ø 80	148	78	95	23	10	700
F071100010	Ø 100	148	96	95	23	10	700

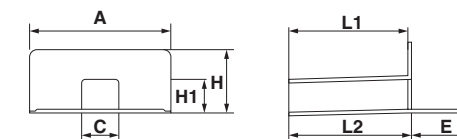
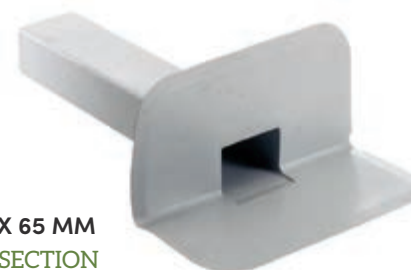

SEZIONE 100 X 65 MM  
100 X 65 MM SECTION

CODICE CODE	TIPO TYPE	A	C	E	H	H1	L1	L2	PAG LISTINO PRICE LIST PAGE	PZ	PZ
A062425065	90°	340	92	145	168	62	425	425	23	8	112

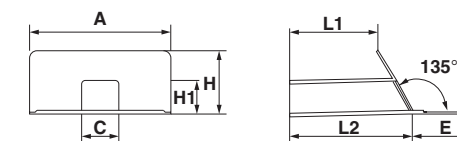

SEZIONE 100 X 65 MM  
100 X 65 MM SECTION

CODICE CODE	TIPO TYPE	A	C	E	H	H1	L1	L2	PAG LISTINO PRICE LIST PAGE	PZ	PZ
A060425065	135°	340	95	145	115	62	340	425	23	10	140

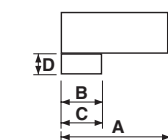

RACCORDO SEZIONE 100 X 65 MM  
PIPE ADAPTOR 100 X 100 MM SECTION

CODICE CODE	MISURA SIZE	A	B	C	D	H	PAG LISTINO PRICE LIST PAGE	PZ	PZ
F072063080	Ø 63 - 80	218	63	80	45	65	23	10	360
F072080100	Ø 80 - 100	218	80	100	62	65	23	10	360

**Bocchettone angolare**  
*Angular roof drain*

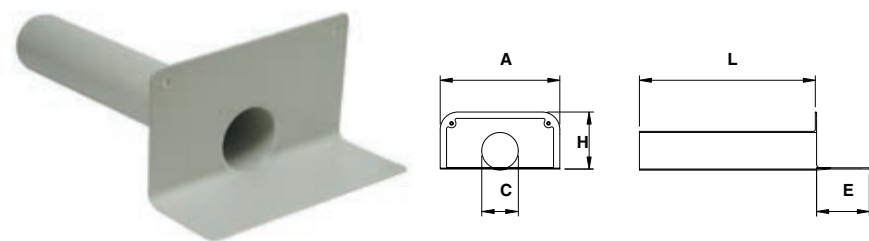

**BOCCHETTONE ANGOLARE USCITA TONDA**  
*ANGULAR DRAIN WITH ROUND SPIGOT*

CODICE CODE	PER TUBI FOR PIPES	A	C	E	H	L	PAG LISTINO PRICE LIST PAGE	PZ 	PZ 
A046500063	Ø 63	340	63	150	133	500	23	8	80
A046500075	Ø 75	340	75	150	133	500	23	8	80
A046500090	Ø 90	340	90	150	165	500	23	8	80
A046500110	Ø 110	340	110	150	165	500	23	8	80
A046500125	Ø 125	340	125	150	165	500	23	7	70

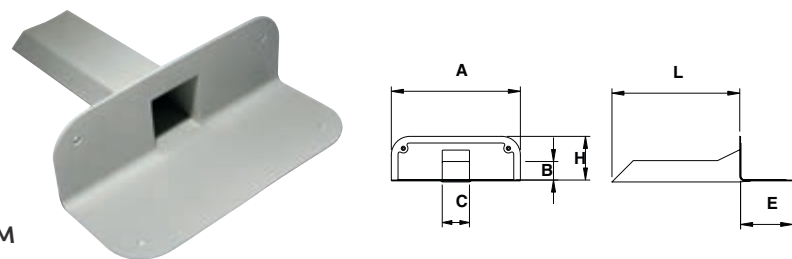

**SEZIONE 57 X 78 MM**  
*57 X 78 MM SECTION*

CODICE CODE	TIPO TYPE	A	B	C	E	H	L	PAG LISTINO PRICE LIST PAGE	PZ 	PZ 
A044347000	Grigio Grey	348	57	78	140	120	347	24	5	140



# ESALATORI IN PVC SEMPLICI E DOPPI

*SIMPLE WALL AND DOUBLE WALL PVC ROOF VENTS*



**Esalatore in PVC semplice e doppio - protezione circolare**  
*Simple wall and double wall PVC roof vents - protection collar*

**SEMPLICE H 225 MM**  
*SIMPLE H 225 MM*

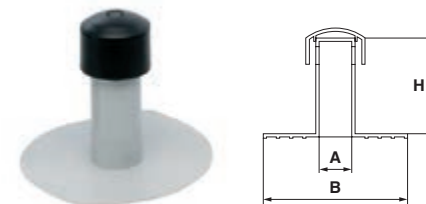

CODICE CODE	Ø ESTERNO Ø EXTERNAL	A	B	H	PAG LISTINO PRICE LIST PAGE	PZ 	PZ 
D070225075	75	72	300	225	25	20	180

**DOPPIO H 225 MM**  
*DOUBLE H 225 MM*

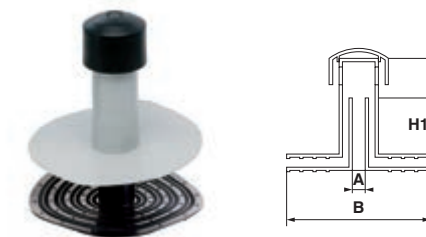

CODICE CODE	Ø ESTERNO Ø EXTERNAL	A	B	H	H1	PAG LISTINO PRICE LIST PAGE	PZ 	PZ 
D080225075	75	60	300	225	190	25	20	180

**SEMPLICE H 400 MM**  
*SIMPLE WALL H 400 MM*

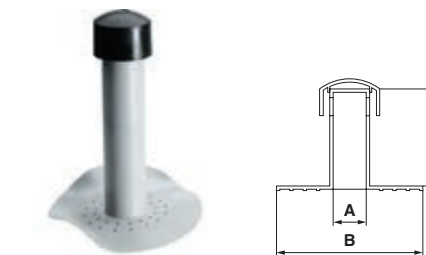

CODICE CODE	Ø ESTERNO Ø EXTERNAL	A	B	H	PAG LISTINO PRICE LIST PAGE	PZ 	PZ 
D070400075	75	72	300	400	25	12	96

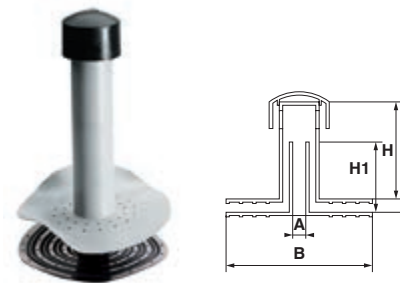

**DOPPIO H 400 MM**  
DOUBLE H 400 MM

CODICE CODE	Ø ESTERNO Ø EXTERNAL	A	B	H	H1	PAG LISTINO PRICE LIST PAGE	PZ	PZ
D080400075	75	60	300	400	190	25	12	96



**PROTEZIONE CIRCOLARE**  
PROTECTION COLLAR

CODICE CODE	TIPO TYPE	Ø	A	B	H	PAG LISTINO PRICE LIST PAGE	PZ	PZ
D150000000	Protezione circolare Ø 75 mm Protection collar Ø 75 mm	-	75	180	60	25	25	1750

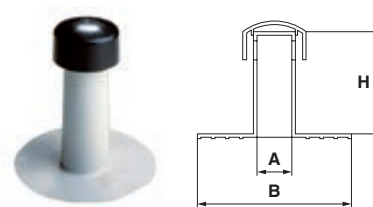

**"MAXI" SEMPLICE H 270 MM**  
"MAXI" SIMPLE H 270 MM

CODICE CODE	Ø ESTERNO Ø EXTERNAL	A	B	H	H1	PAG LISTINO PRICE LIST PAGE	PZ	PZ
D070270110	105	100	300	270	190	25	15	135

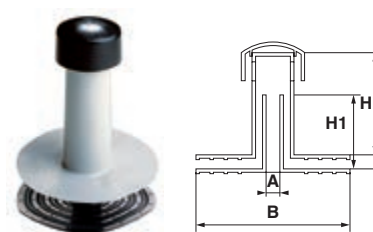

**"MAXI" DOPPIO H 270 MM**  
"MAXI" DOUBLE H 270 MM

CODICE CODE	Ø ESTERNO Ø EXTERNAL	A	B	H	H1	PAG LISTINO PRICE LIST PAGE	PZ	PZ
D101270110	105	60	300	270	190	25	15	135

PVC

PVC

SSS

PVC

PVC

SSS

### Esalatore in PVC coibentato - protezione circolare

#### Insulated simple and double wall PVC roof vents - protection collar

IT

L'esalatore coibentato, grazie alla coibentazione in polistirolo presente nella parete esterna, elimina il rischio di condensa dovuto alla differenza di temperatura fra l'ambiente interno ed esterno. Come per tutti gli altri modelli, anche l'esalatore coibentato è disponibile nei modelli "semplice" e "doppio" ed è completato dalla protezione circolare.

EN

Thanks to the internal polystyrene insulation body, which allows the moisture to get out through the dome more easily, this type of vent pipe eliminates any risk of condensation due to the difference in temperature between the outside and the inside. As for all the other vent pipes, it is also available in the "simple" and "double wall" versions along with a proper protection collar.



**SEMPLICE H 225 MM**  
SIMPLE WALL H 225 MM

CODICE CODE	Ø ESTERNO Ø EXTERNAL	A	B	H	PAG LISTINO PRICE LIST PAGE	PZ	PZ
D090225075	105	72	300	225	24	20	180

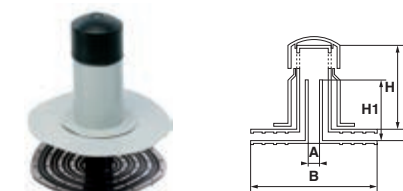

**DOPPIO H 225 MM**  
DOUBLE H 225 MM

CODICE CODE	Ø ESTERNO Ø EXTERNAL	A	B	H	H1	PAG LISTINO PRICE LIST PAGE	PZ	PZ
D100225075	105	60	300	225	190	24	20	180



**PROTEZIONE CIRCOLARE**  
PROTECTION COLLAR

CODICE CODE	Ø ESTERNO Ø EXTERNAL	A	B	H	PAG LISTINO PRICE LIST PAGE	PZ	PZ
D160000000	110	105	205	60	24	20	1400



# ANGOLI IN PVC

## PVC CORNER

PVC

PVC

SSS

IT

Gli angoli interni ed esterni in PVC sono elementi estremamente importanti e necessari al completamento di una impermeabilizzazione con membrane monostrato in PVC. Servono infatti a proteggere e rinforzare gli spigoli e gli angoli presenti nella copertura da impermeabilizzare per esempio in presenza di muri e lucernari. La gamma "Eterno" si compone di 3 distinti modelli, diversi tra loro per dimensioni. Il modello "Mini" con una altezza di 70 mm. Il modello "Medio" altezza di 95 mm. L'esclusiva versione "Maxi" è infine un modello unico per ampiezza di dimensioni con un'altezza di ben 150 mm.

EN

PVC internal and external corners are element of a high importance and needed to finish a waterproofing with single-ply PVC membranes. The main purpose of these items is to protect and reinforce the waterproofing sheet on corners and edges (internal and external corners) like for example in presence of walls and skylights. The "Eterno" range offers 3 different types of corners with different sizes. Brand "Mini" type is only 70 mm high and is the cheaper version in the range. The "Medium" version is 95 mm height. Thanks to its large surface (150 mm high), the exclusive "Maxi" type is ultimately a unique version.



### ANGOLO INTERNO "MINI"

#### INTERNAL CORNER "MINI"

CODICE CODE	A	B	H	PAG LISTINO PRICE LIST PAGE	PZ 	PZ 
F011000200	70	-	70	26	350	-

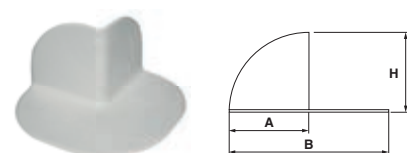

### ANGOLO ESTERNO "MINI"

#### EXTERNAL CORNER "MINI"

CODICE CODE	A	B	H	PAG LISTINO PRICE LIST PAGE	PZ 	PZ 
F010000200	67	128	70	26	200	-

68

ETERNO IVICA · ETERNO

PVC

PVC

SSS



### ANGOLO INTERNO "MEDIO"

#### INTERNAL CORNER "MEDIUM"

CODICE CODE	A	B	H	PAG LISTINO PRICE LIST PAGE	PZ 	PZ 
F011000100	95	-	95	26	200	6000



### ANGOLO ESTERNO "MEDIO"

#### EXTERNAL CORNER "MEDIUM"

CODICE CODE	A	B	H	PAG LISTINO PRICE LIST PAGE	PZ 	PZ 
F010000100	93	173	100	26	100	3000*



### ANGOLO INTERNO "MAXI"

#### INTERNAL CORNER "MAXI"

CODICE CODE	A	B	H	PAG LISTINO PRICE LIST PAGE	PZ 	PZ 
F011000030	150	-	150	26	80	1600*

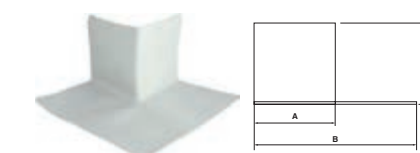

### ANGOLO ESTERNO "MAXI"

#### EXTERNAL CORNER "MAXI"

CODICE CODE	A	B	H	PAG LISTINO PRICE LIST PAGE	PZ 	PZ 
F010000030	150	300	150	26	40	800*

\* Dimensioni pallet mm 1200 x 800 x h 1100

\* Pallet size mm 1200 x 800 x h 1100

69

ETERNO IVICA · ETERNO

# RACCORDI IN PVC

## PVC BASE FITTING

PVC

PVC

SSS

IT

I raccordi vengono applicati nei casi in cui fuoriescano dei tubi di sfiato dal solaio di copertura. L'applicazione è molto semplice: basta tagliare in corrispondenza della sezione richiesta, inserirlo all'esterno del tubo e sigillare mediante fascetta metallica stringitubo.

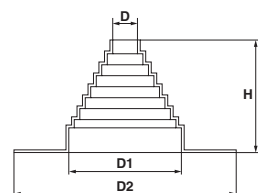

EN

The fittings should be applied in cases where the vent pipes come out of the roofing floor. Application is very easy: simply cut according to the section required, slip it on the pipe and seal using a metal pipe clamp.



### RACCORDO PER TUBI IN PVC

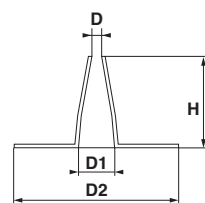

#### PVC BASE FITTING FOR PIPES

CODICE CODE	D	D1	D2	H	PAG LISTINO PRICE LIST PAGE	PZ 	PZ 
F002000000	40	175	395	190	26	12	360



### RACCORDO CONICO IN PVC

#### PVC CONICAL BASE FITTING FOR PIPES

CODICE CODE	D	D1	D2	H	PAG LISTINO PRICE LIST PAGE	PZ 	PZ 
F012000000	15	55	210	120	26	50	2100

# PROFILI PERIMETRALI IN PVC

## PVC PROFILES

PVC

PVC

SSS

IT

I raccordi vengono applicati nei casi in cui fuoriescano dei tubi di sfiato dal solaio di copertura. L'applicazione è molto semplice: basta tagliare in corrispondenza della sezione richiesta, inserirlo all'esterno del tubo e sigillare mediante fascetta metallica stringitubo.

EN

The fittings should be applied in cases where the vent pipes come out of the roofing floor. Application is very easy: simply cut according to the section required, slip it on the pipe and seal using a metal pipe clamp.

- 1 Profilo a parete  
sviluppo 70 mm - lunghezza 2 mt

Perimetral wall profile  
height 70 mm - length 2 mt





- 2 Piattina di fissaggio  
sviluppo 50 mm - lunghezza 2 mt

Fixing flat element  
height 50 mm - length 2 mt



### PROFILI PERIMETRALI IN PVC

#### PVC PERIMETRAL WALL PROFILE

CODICE CODE	ALTEZZA HEIGHT	LUNGHEZZA LENGTH	PAG LISTINO PRICE LIST PAGE	PZ 	PZ 
F041007002	70 mm	200 mm	28	2	-
F040005002	50 mm	200 mm	28	2	-

# ACCESSORI PER MEMBRANE SINTETICHE IN POLIOLEFINE (TPO)

## ACCESSORIES FOR TPO SYNTHETIC MEMBRANES



IT

Per le sue caratteristiche di efficacia, resistenza e durata, il Poliolefine TPO sta diventando un materiale sempre più richiesto nelle impermeabilizzazioni.

Eterno Ivica produce accessori specifici per guaine sintetiche sin dall'apparire sul mercato di questa tipologia di materiali: ecco perché ha acquisito un'esperienza tecnica insuperabile.

Gli accessori Eterno Ivica in TPO possono essere utilizzati in tutte le coperture piane: a tetto sia caldo sia rovescio, zavorrate e non zavorrate.

EN

*Thanks to its effectiveness, strength and durability, Thermoplastic Polyolefin (TPO) is becoming increasingly used as a waterproofing material.*

*Eterno Ivica has been manufacturing specific accessories for synthetic roofing felts since these types of materials appeared on the market, and has thus succeeded in acquiring unrivalled technical expertise.*

*Eterno Ivica's TPO accessories can be used for all types of flat roofing applications: whether hot, reverse, ballasted or non-ballasted.*

## BOCCHETTONI "EURO" IN TPO "EURO" TPO ROOF DRAIN

## BOCCHETTONI ANGOLARI IN TPO ANGULAR TPO DRAIN

## ESALATORI IN TPO TPO WALL POLYOLEFYNE ROOF VENT

## ANGOLI IN TPO TPO CORNER

## RACCORDI E PROFILI PERIMETRALI IN TPO TPO BASE FITTINGS AND PROFILES



# BOCCHETTONI "EURO" IN TPO

"EURO" TPO ROOF MADE OF DRAIN



IT

Realizzati in Poliolefine universale di colore bianco, sono creati per garantire la massima compatibilità con qualsiasi membrana in Poliolefine. La flangia è liscia per consentire una perfetta fusione con le membrane impermeabili. Il codolo è dotato di due coppie di alette antiriflusso.

EN

Manufactured of universal Polyolefine white, they are made to guarantee a perfect compatibility to any sort of TPO waterproofing membrane. The flange is totally smooth for a perfect bonding to the waterproofing membrane. The spigot is provided with two couples of anti - infiltration tongues.

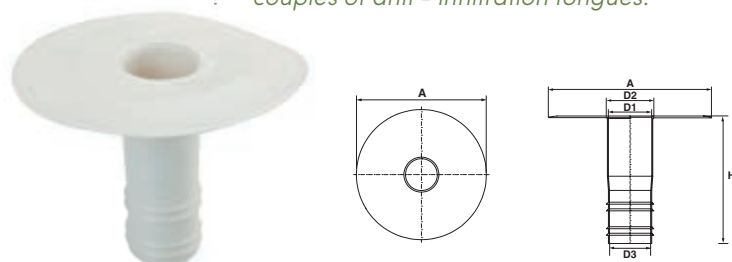

**BOCCHETTONE "EURO" IN POLIOLEFINE (TPO) CON CODOLO H 250 MM**  
 "EURO" ROOF DRAIN MADE OF POLYOLEFYNE (TPO) WITH A 250 MM SPIGOT

CODICE - HIFAX CODE - HIFAX	CODICE - ADFLEX* CODE - ADFLEX*	PER TUBI FOR PIPES	A	D1	D2	D3	H	PAG LISTINO PRICE LIST PAGE	PZ	PZ
A015225063	A015025063	63	320	51	60	49	250	27	15	240
A015225075	A015025075	75	320	63	70	62	250	27	15	240
A015225082	A015025082	82	320	69	75	68	250	27	15	240
A015225090	A015025090	90	320	80	84	79	250	27	15	240
A015225100	A015025100	100	320	86	90	85	250	27	15	240
A015225110	A015025110	110	380	95	101	94	250	27	15	240
A015225125	A015025125	125	380	109	115	108	250	27	15	240
A015225140	A015025140	140	380	128	134	127	250	27	10	160
A015225150	A015025150	150	380	134	140	132	250	27	10	160
A015225160	A015025160	160	380	140	146	139	250	27	10	160

\* Prodotto ADFLEX a richiesta

\* ADFLEX type on request

# BOCCHETTONI ANGOLARI IN TPO

ANGULAR TPO DRAIN



IT

Realizzato in Poliolefine universale di colore bianco, è creato per garantire la massima compatibilità con qualsiasi membrana in Poliolefine. È dotato di raccordi per i tubi di scarico, vedi pagina 50-51.

EN

Manufactured of universal Polyolefine white, they are made to guarantee a perfect compatibility to any sort of TPO waterproofing membrane. See on pages 50-51 for pipe adaptors.

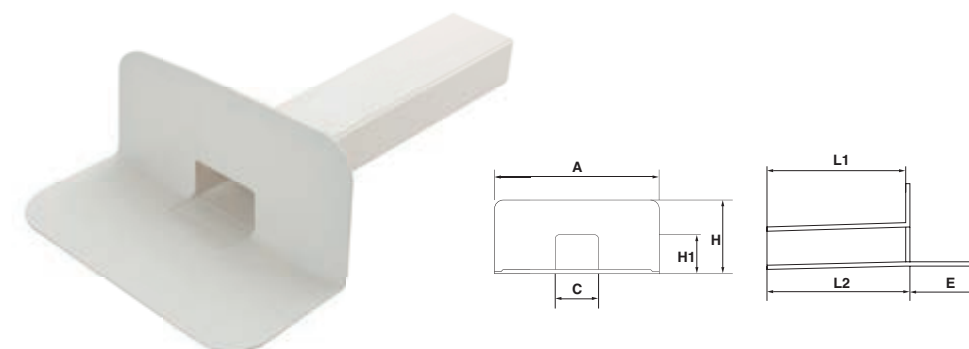

**BOCCHETTONE ANGOLARE 90° - L 425 MM IN POLIOLEFINE (TPO)**  
 ANGULAR DRAIN 90° - L 425 MM MADE OF POLYOLEFYNE (TPO)

CODICE - HIFAX CODE - HIFAX	CODICE - ADFLEX* CODE - ADFLEX*	PER TUBI FOR PIPES	A	C	E	H	H1	L1	L2	PAG LISTINO PRICE LIST PAGE	PZ	PZ
A042425265	A042425165	100 x 65 - 90°	340	92	145	168	62	425	425	27	8	112

\* Prodotto ADFLEX a richiesta

\* ADFLEX type on request

# ESALATORI IN TPO

TPO WALL POLYOLEFENE ROOF VENT



IT

Realizzati in Poliolefine universale di colore bianco, questi esalatori sono creati per garantire la massima compatibilità con qualsiasi membrana in Poliolefine. Disponibili in due modelli, il tipo "semplice", che si usa solo in presenza di membrana impermeabile, il tipo "doppio" che si usa nel caso venga applicato un pannello isolante. Raccomandiamo l'utilizzo dell'apposita protezione circolare.

EN

Manufactured of universal Polyolefine white, they are made to guarantee a perfect compatibility to any sort of TPO waterproofing membrane. It is available in the following models: the simple wall version used in case of a simple waterproofing membrane and the double wall version used in the presence of insulating boards. For a further protection, a specific collar is also provided.

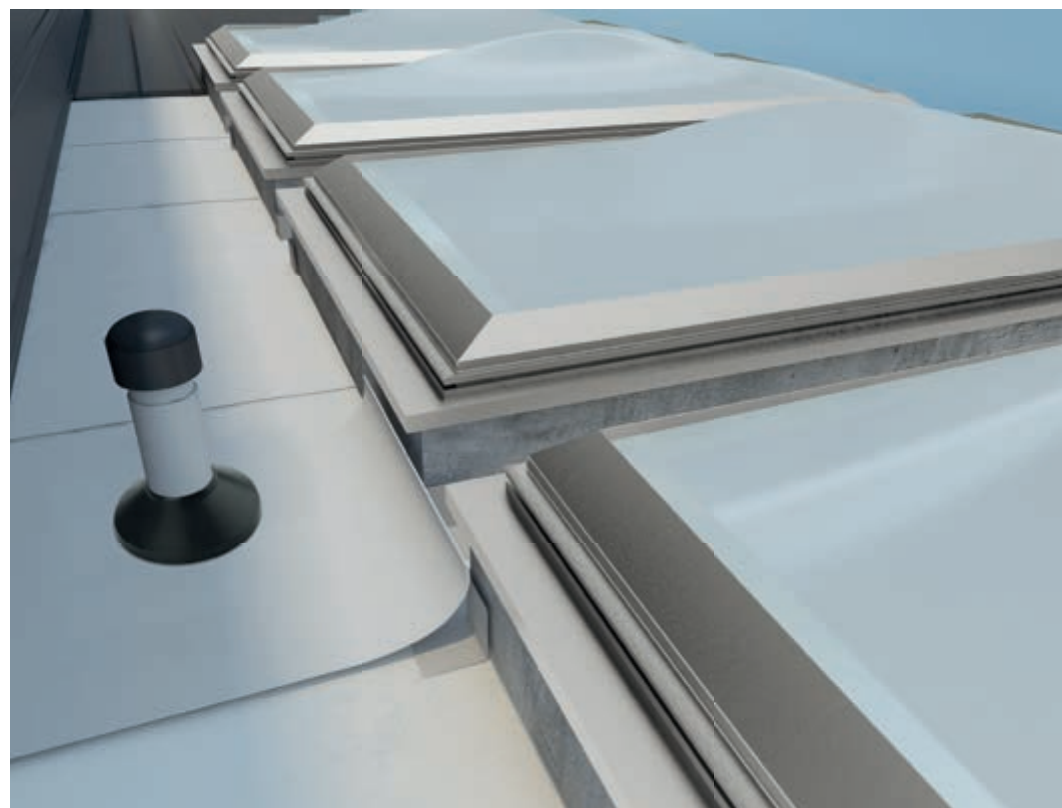

SEMPLICE H 225 MM  
SIMPLE H 225 MM

CODICE - HIFAX CODE - HIFAX	CODICE - ADFLEX* CODE - ADFLEX*	TIPO TYPE	Ø ESTERNO Ø EXTERNAL	A	B	H	H1	PAG LISTINO PRICE LIST PAGE	PZ	PZ
D401325075	D401225075	Semplice Simple wall	75	72	300	225	-	28	15	225

\* Prodotto ADFLEX a richiesta

\* ADFLEX type on request



DOPPIO H 225 MM  
DOUBLE H 225 MM

CODICE - HIFAX CODE - HIFAX	CODICE - ADFLEX* CODE - ADFLEX*	TIPO TYPE	Ø ESTERNO Ø EXTERNAL	A	B	H	H1	PAG LISTINO PRICE LIST PAGE	PZ	PZ
D410325075	D410225075	Doppio Double wall	75	60	300	225	190	28	25	225

\* Prodotto ADFLEX a richiesta

\* ADFLEX type on request



PROTEZIONE CIRCOLARE  
PROTECTION COLLAR

CODICE CODE	TIPO TYPE	A	B	H	H1	PAG LISTINO PRICE LIST PAGE	PZ	PZ
D150000000	Protezione circolare Protection collar	75	180	60	-	28	25	1750

# ANGOLI IN TPO

## TPO CORNER



IT

Gli angoli interni ed esterni in TPO sono elementi molto importanti ed indispensabili al completamento di una impermeabilizzazione con membrane poliolefiniche. Servono infatti a proteggere e rinforzare gli spigoli e gli angoli presenti nella copertura da impermeabilizzare per esempio in presenza di muri e lucernari. Sono disponibili nei modelli "Mini", "Medio" e l'esclusiva versione "Maxi" con un'altezza di ben 150 mm per offrire una superficie impermeabilizzante davvero fuori standard.

EN

TPO internal and external corners are element of a high importance and needed to finish a waterproofing with single-ply TPO membranes. The main purpose of these items is to protect and reinforce the waterproofing sheet on corners and edges in presence of walls and skylights. They are available in different types: the brand new "Mini" type, "Medium" and the exclusive "Maxi" type that thanks to its large surface (150mm high) is a unique version that offers a very wide waterproofing area.



### ANGOLO INTERNO "MINI"

#### INTERNAL CORNER "MINI"

CODICE - HIFAX CODE - HIFAX	CODICE - ADFLEX* CODE - ADFLEX*	A	B	H	PAG LISTINO PRICE LIST PAGE	PZ 	PZ 
F011004200	F011004210	70	-	70	29	350	-

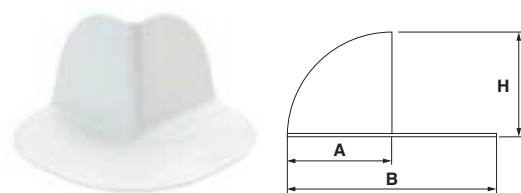

### ANGOLO ESTERNO "MINI"

#### EXTERNAL CORNER "MINI"

CODICE - HIFAX CODE - HIFAX	CODICE - ADFLEX* CODE - ADFLEX*	A	B	H	PAG LISTINO PRICE LIST PAGE	PZ 	PZ 
F010004200	F010004210	67	128	70	29	200	-

78

ETERNO IVICA · ETERNO

TPO

TPO

SSS



### ANGOLO INTERNO "MEDIO"

#### INTERNAL CORNER "MEDIUM"

CODICE - HIFAX CODE - HIFAX	CODICE - ADFLEX* CODE - ADFLEX*	A	B	H	PAG LISTINO PRICE LIST PAGE	PZ 	PZ 
F011004200	F011004210	95	-	95	29	200	6000

\* Prodotto ADFLEX a richiesta



### ANGOLO ESTERNO "MEDIO"

#### EXTERNAL CORNER "MEDIUM"

CODICE - HIFAX CODE - HIFAX	CODICE - ADFLEX* CODE - ADFLEX*	A	B	H	PAG LISTINO PRICE LIST PAGE	PZ 	PZ 
F010004020	F010004000	93	173	100	29	100	3000

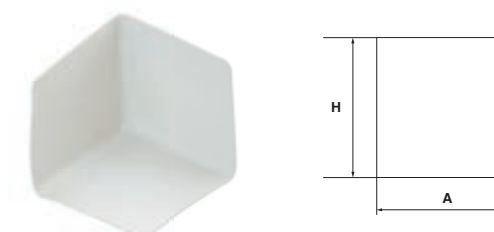

### ANGOLO INTERNO "MAXI"

#### INTERNAL CORNER "MAXI"

CODICE - HIFAX CODE - HIFAX	CODICE - ADFLEX* CODE - ADFLEX*	A	B	H	PAG LISTINO PRICE LIST PAGE	PZ 	PZ 
F011004030	F011004040	150	-	150	29	80	1600

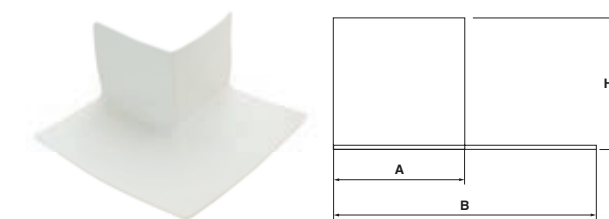

### ANGOLO ESTERNO "MAXI"

#### EXTERNAL CORNER "MAXI"

CODICE - HIFAX CODE - HIFAX	CODICE - ADFLEX* CODE - ADFLEX*	A	B	H	PAG LISTINO PRICE LIST PAGE	PZ 	PZ 
F010004030	F010004040	150	400	150	29	40	800

\* Prodotto ADFLEX a richiesta

\* ADFLEX type on request

79

ETERNO IVICA · ETERNO



# RACCORDI E PROFILI PERIMETRALI IN TPO

TPO BASE FITTINGS AND PROFILES

TPO

TPO

SSS

IT

I raccordi vengono applicati nei casi in cui fuoriescano dei tubi di sfato dal solaio di copertura. L'applicazione è molto semplice, basta tagliare in corrispondenza della sezione richiesta, inserirlo all'esterno del tubo e sigillare mediante fascetta metallica stringitubo.

EN

Base fittings are available to solve the problem of ventilation pipes coming out from the roofing floor. The application is very simple. The base fittings shall be cut according to the pipe diameter required and then slipped on to the pipe. A metal ring to squeeze the rubber connection around the pipe will finish the operation.

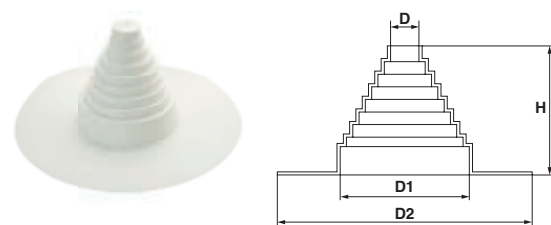

## RACCORDO PER TUBI IN TPO TPO BASE FITTING FOR PIPES

CODICE - HIFAX CODE - HIFAX	CODICE - ADFLEX* CODE - ADFLEX*	D	D1	D2	H	PAG LISTINO PRICE LIST PAGE	PZ 	PZ 
F002003010	F002003000	40	175	395	190	29	12	360

\* Prodotto ADFLEX a richiesta

\* ADFLEX type on request



## RACCORDO CONICO IN TPO TPO CONICAL BASE FITTING FOR PIPES

CODICE - HIFAX CODE - HIFAX	CODICE - ADFLEX* CODE - ADFLEX*	D	D1	D2	H	PAG LISTINO PRICE LIST PAGE	PZ 	PZ 
F013003002	F013003000	15	55	210	120p	29	50	2100

\* Prodotto ADFLEX a richiesta

\* ADFLEX type on request

TPO

TPO

SSS

IT

I profili perimetrali sono compatibili con qualsiasi membrana impermeabile in Poliolefine (TPO). Sono realizzati in lamiera zincata accoppiata ad una membrana TPO.

EN

This kind of profile is perfectly compatible to any kind of TPO waterproofing membrane. It is manufactured with galvanized-plate combined to a TPO sheet.

- 1 Profilo a parete  
sviluppo 70 mm - lunghezza 2 mt

Perimetral wall profile  
height 70 mm - length 2 mt



- 2 Piattina di fissaggio  
sviluppo 50 mm - lunghezza 2 mt

Fixing flat element  
height 50 mm - length 2 mt



## PROFILI PERIMETRALI IN TPO TPO PERIMETRAL PROFILES

CODICE CODE	ALTEZZA HEIGHT	LUNGHEZZA LENGTH	PAG LISTINO PRICE LIST PAGE	PZ 	PZ 
F041107002	70 mm	200 mm	28	2	-
F040105002	50 mm	200 mm	28	2	-



> POSA IN OPERA ACCESSORI PER MANTI SINTETICI PVC-TPO  
> ACCESSORIES FOR PVC-TPO LAYERS INSTALLATION

# PARAFOGLIA E PARAGHIAIA

*LEAF-GUARDS AND GRAVEL-GUARD*



PARAFOGLIA STANDARD IN PP  
*PP STANDARD LEAF-GUARD*

PARAFOGLIA UNIVERSALE IN PP  
*PP UNIVERSAL LEAF-GUARD*

PARAFOGLIA ANGOLARE  
*LEAF-GUARD FOR ANGULAR DRAIN*

PARAFOGLIA UNIVERSALE IN ZINCO, RAME, ACCIAIO  
*FLEXIBLE ZINC, COPPER, STAINLESS STEEL LEAF-GUARD*

PARAGHIAIA, PROLUNGA, ASTA  
*GRAVEL-GUARD, EXTENSION RING, UNIVERSAL ADAPTOR*

PARAGHIAIA SPAGNA E RETE PROTEGGI GRONDE  
*GRAVEL-GUARD SPAIN AND EAVES GUTTER-GUARD*

# PARAFOGLIA STANDARD IN PP

## PP STANDARD LEAF-GUARD

PP

IT

Per proteggere le condotte di scarico da foglie e sporcizia in genere, raccomandiamo di applicare la parafoglia al bocchettone. La gamma "Eterno" offre più di una possibilità: una parafoglia in PP a misura fissa, da Ø 60 a 200 mm, una parafoglia in PP a misura variabile da Ø 60 a 140 mm, una parafoglia metallica in zinco, rame o acciaio inox a misura variabile da Ø 60 a 120 mm, una parafoglia specifica per bocchettoni angolari a 45°.

### PARAFOGLIA PP A MISURA FISSA FIXED SIZE PP LEAF-GUARD

CODICE CODE	"ETERNO" H 200 Ø	"ETERNO" H 500 Ø	"MONDIAL" Ø	"EURO" "GENIUS" Ø
C001000060	50 - 60		60	
C001000075	75			
C001000080	80		80	90
C001001080				82
C001000090	90	80		100
C001000100	100		100	
C001000110	110			110
C001000120	120		120	125
C001001120		100		
C001000125	125			
C001000140	140	120		140
C001000150	150		150	150
C001000160	160	150		
C001000200	200			

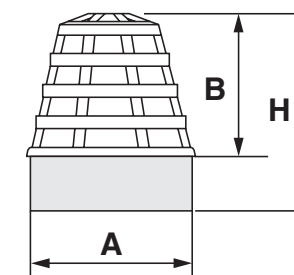

EN

To protect the drain-pipe from leaves and dirt, we always recommend to install a leaf-guard on the roof drain. The "Eterno" range offers leaf-guards made of PP with fixed size from 60 to 200 mm diameter, a PP leafguard with variable size from 60 to 140 mm diameter, metallic leafguards made of zinc, copper and stainless steel with variable size from Ø 60 to Ø 120 mm, and a specific PP leaf-guard for angular drains with a 45° corner.



Individua il diametro del tuo bocchettone e scegli il parafoglia corrispondente.

Match the diameter of your drain and choose the right leaf guard.

CODICE CODE	Ø	A	B	H	PAG LISTINO PRICE LIST PAGE	PZ 	PZ 
C001000060	60	47	54	84	30	25	1750
C001000075	75	62	75	105	30	25	1750
C001000080	80	68	70	100	30	25	1750
C001001080	80L	68	70	100	30	25	1750
C001000090	90	78	70	100	30	25	1750
C001000100	100	88	70	100	30	25	1750
C001000110	110	92	70	100	30	25	1750
C001000120	120	100	70	100	30	25	1750
C001001120	120L	100	70	100	30	25	1750
C001000125	125	109	70	100	30	20	1400
C001000140	140	125	70	100	30	20	1400
C001000150	150	130	70	100	30	15	1050
C001000160	160	143	75	105	30	15	1050
C001000200	200	177	75	105	30	10	700



# PARAFOGLIA UNIVERSALE IN PP

FLEXIBLE PP LEAF-GUARD

PP

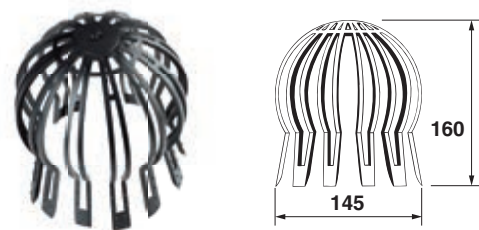

PARAFOGLIA UNIVERSALE IN PP  
FLEXIBLE PP LEAF-GUARD

CODICE CODE	MISURA SIZE	TIPO TYPE	PAG LISTINO PRICE LIST PAGE	PZ 	PZ 
C005000000	60 ÷ 140	Special PP	31	100	2000
C005000001	60 ÷ 140	"Standard" PP	31	100	2000

# PARAFOGLIA UNIVERSALE IN ZINCO, RAME, ACCIAIO

FLEXIBLE ZINC, COPPER, STAINLESS STEEL LEAF-GUARD

INOX

CU

ZN

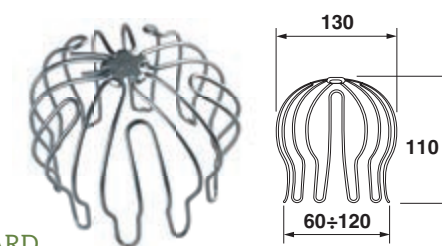

PARAFOGLIA UNIVERSALE IN ZINCO, RAME, ACCIAIO  
FLEXIBLE ZINC, COPPER, STAINLESS STEEL LEAF-GUARD

CODICE CODE	MISURA SIZE	TIPO TYPE	PAG LISTINO PRICE LIST PAGE	PZ 	PZ 
C002000000	60 ÷ 120	Zinco <i>Zinc</i>	31	50	3600
C003000000	60 ÷ 120	Rame <i>Copper</i>	31	50	3600
C004000000	60 ÷ 120	Acciaio Inox <i>Stainless steel</i>	31	50	3600

# PARAFOGLIA ANGOLARE

LEAF-GUARD FOR ANGULAR DRAIN

PP

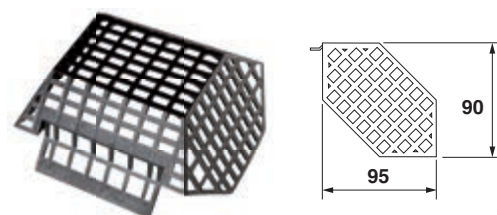

PARAFOGLIA ANGOLARE  
LEAF-GUARD FOR ANGULAR DRAIN

CODICE CODE	MISURA SIZE	TIPO TYPE	PAG LISTINO PRICE LIST PAGE	PZ 	PZ 
C020000045	Per bocchettone angolare 45° <i>For 45° angular drain</i>	-	31	20	1400

# PARAGHIAIA, PROLUNGA, ASTA

EXTENSION, UNIVERSAL ADAPTER

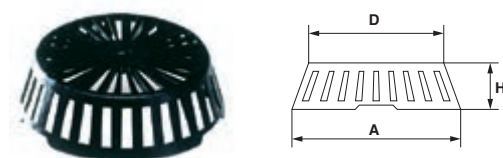

PARAGHIAIA  
GRAVEL-GUARD

CODICE CODE	A	D	H	PAG LISTINO PRICE LIST PAGE	PZ 	PZ 
C023000000	195	170	50	32	50	1000

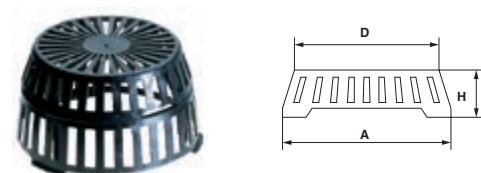

PROLUNGA  
EXTENSION RING

CODICE CODE	A	D	H	PAG LISTINO PRICE LIST PAGE	PZ 	PZ 
C024000000	215	195	65	32	50	1000

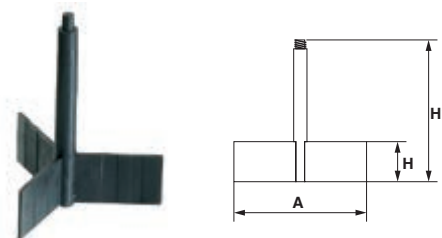

ASTA UNIVERSALE  
UNIVERSAL ADAPTER

CODICE CODE	A	H	H1	PAG LISTINO PRICE LIST PAGE	PZ 	PZ 
C025000000	130	40	150	32	50	3500

# PARAGHIAIA SPAGNA E RETE PROTEGGI GRONDE

GRAVEL-GUARD SPAIN AND EAVES GUTTER-GUARD

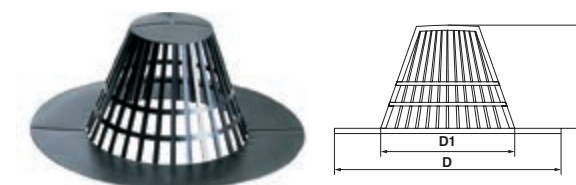

PARAGHIAIA MODELLO SPAGNA  
GRAVEL-GUARD SPAIN VERSION

CODICE CODE	D	D1	H	PAG LISTINO PRICE LIST PAGE	PZ 	PZ 
C027000000	335	198	150	32	25	500

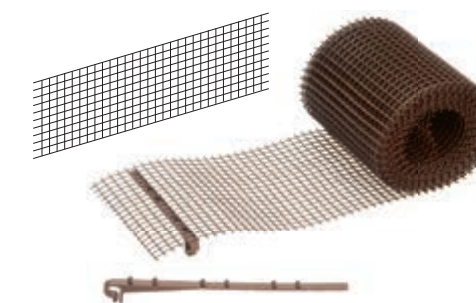

RETE PROTEGGI-GRONDE  
EAVES GUTTER-GUARD

CODICE CODE	MISURA SIZE	COLORE COLOUR	PAG LISTINO PRICE LIST PAGE	PZ 	PZ 
F128002618	mt 6 x cm 18	Marrone Brown	32	12	300
F128002624	mt 6 x cm 24	Marrone Brown	32	10	250

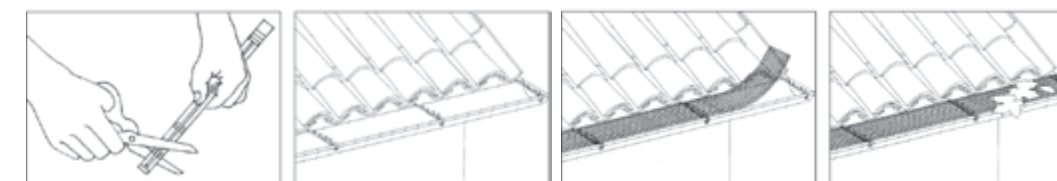

# SALVASPORGENZE E PETTINI ANTINIDO

*EAVE-COMB FILLER AND  
ANTI-NEST COMB*

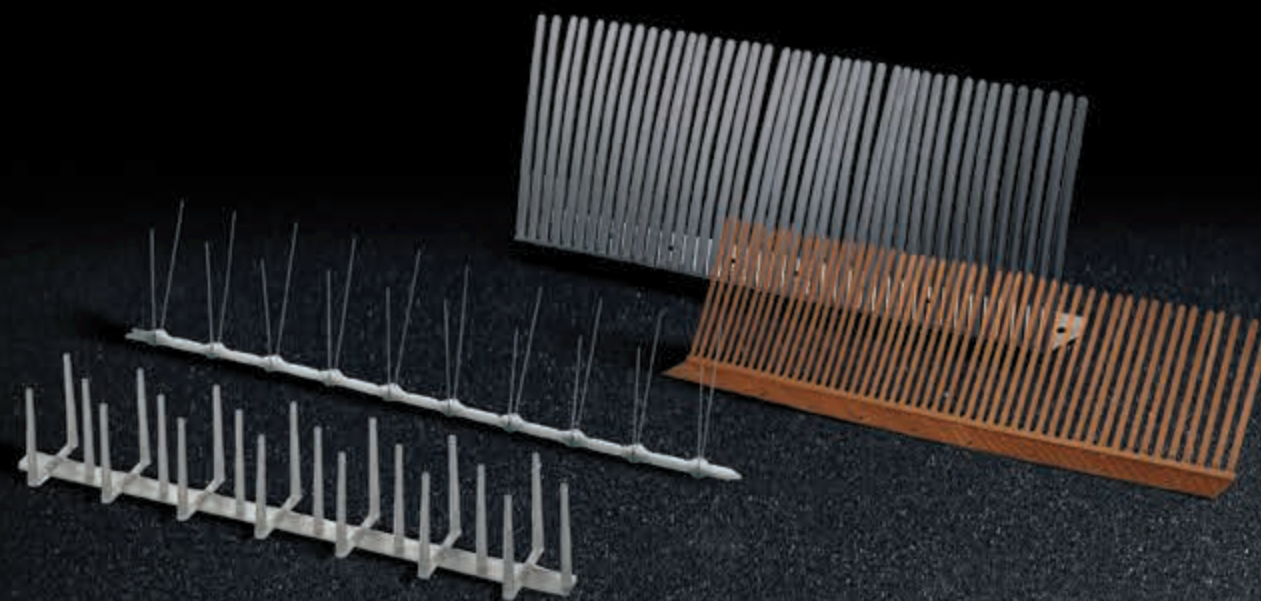

SALVASPORGENZE IN PP

*PP EAVE COMB FILLER*

SALVASPORGENZE METALLICO "STANDARD"

*"STANDARD" METAL EAVE COMB FILLER*

SALVASPORGENZE METALLICO "SPECIAL"

*"SPECIAL" METAL EAVE COMB FILLER*

SALVASPORGENZE METALLICO "INOX"

*"INOX" METAL EAVE COMB FILLER*

PETTINE ANTINIDO IN PP

*PP ANTI-NEST COMB*

PETTINE ANTINIDO IN LAMIERA PREVERNICIATA

*ANTI-NEST COMB IN PRE-PAINTED SHEET METAL*

PETTINE ANTINIDO IN RAME

*COPPER ANTI-NEST COMB*



# SALVASPORGENZE IN PP

PP EAVE COMB FILLER



CODICE CODE	TIPO TYPE	A	B	C	H	PAG LISTINO PRICE LIST PAGE	PZ 	PZ 
F122008333	Neutro <i>Neutral</i>	500	55	25	80	33	100	800

# SALVASPORGENZE METALLICO "SPECIAL"

"SPECIAL" METAL EAVE COMB FILLER



CODICE CODE	A	B	C	H	PAG LISTINO PRICE LIST PAGE	PZ 	PZ 
F124011050	20	50	110	25	33	25	1000

# SALVASPORGENZE METALLICO "STANDARD"

"STANDARD" METAL EAVE COMB FILLER

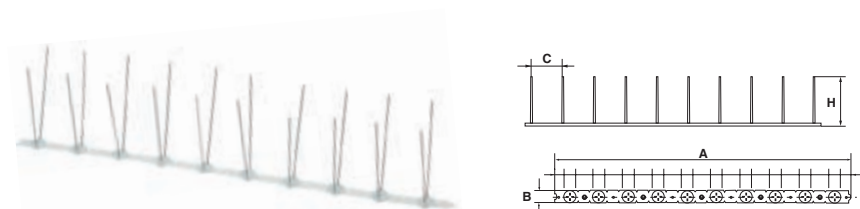

CODICE CODE	A	B	C	H	PAG LISTINO PRICE LIST PAGE	PZ 	PZ 
F123011050	500	20	50	110	33	50	2000

# SALVASPORGENZE METALLICO "INOX"

"INOX" METAL EAVE COMB FILLER





CODICE CODE	A	B	C	H	PAG LISTINO PRICE LIST PAGE	PZ 	PZ 
F125000000	1000	20	50	110	33	25	450

# PETTINE ANTINIDO IN PP

PP ANTI-NEST COMB

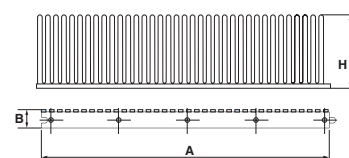
PP





CODICE CODE	TIPO TYPE	COLORE COLOUR	A	B	H	PAG LISTINO PRICE LIST PAGE	PZ 	PZ 
F121010750	PP H 70	Nero Black	500	20	70	33	110	7200
F121010050	PP H 110	Nero Black	500	20	110	33	80	4800
F121011550	PP H 150	Nero Black	500	20	150	33	50	3000

# PETTINE ANTINIDO IN RAME

COPPER ANTI-NEST COMB

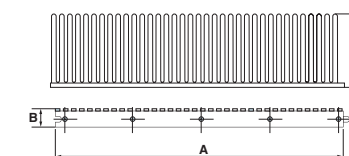
CU





CODICE CODE	TIPO TYPE	COLORE COLOUR	A	B	H	PAG LISTINO PRICE LIST PAGE	PZ 	PZ 
F121020050	Rame H 110 Copper	Rame Copper	500	20	110	33	50	2000

# PETTINE ANTINIDO IN LAMIERA PREVERNICIATA

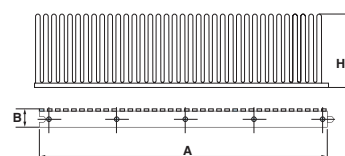
ANTI-NEST COMB IN PRE-PAINTED SHEET METAL



CODICE CODE	TIPO TYPE	COLORE COLOUR	A	B	H	PAG LISTINO PRICE LIST PAGE	PZ 	PZ 
F121030050	Preverniciato H 110 Prepainted	Testa di moro Dark brown	500	20	110	33	50	2000



**LINEA  
LIQUID**

---

**LIQUID LINE**



# NOVITÀ CHE CAMBIANO IL CORSO DELL'ACQUA

**INNOVATIONS THAT CHANGE THE COURSE...OF WATER!**

IT

## La perfezione è anche questione di dettagli

La Linea Liquid, grazie al processo di termofusione tra il fazzoletto e la flangia del chiusino, rappresenta oggi il sistema ideale per eseguire ad arte la posa degli accessori utilizzati per il deflusso delle acque, con risparmio di tempo ed evitando il pericolo di infiltrazioni in corrispondenza degli scarichi. Disponibile in due versioni: rete in fibra di vetro "FV" e tessuto non tessuto "TNT". Dotata di cinque diametri verticali, tre orizzontali, un esalatore, una linea di canalette e uno scarico per poggiatesta, la Gamma Liquid si adatta a tutti i pacchetti impermeabilizzanti e isolanti.

Eterno Ivica, grazie a investimenti costanti in ricerca e sviluppo e un'attenzione irrinunciabile alla qualità, ha creato soluzioni innovative, funzionali ed efficaci, in grado di rispondere in maniera puntuale alle più variegata esigenze dell'edilizia moderna.

I prodotti e i sistemi della gamma Eterno sono studiati e ingegnerizzati per esaltare la bellezza del progetto, incrementare la durata e il valore degli edifici.

EN

## Perfection is in the details

*Thanks to the thermal fusion between the sheet and the cover flange, the Liquid Line has become the ideal system for installing water drainage accessories, offering significant time savings and eliminating the risk of leaks forming around the drains. The system is available in two versions: the FV version with fiberglass mesh, and the TNT version with non-woven fabric. Featuring five vertical, three horizontal diameters and an angular drain for balconies, the Liquid range can be adapted for use with any waterproofing and insulating package. The Grille and Frame, manufactured exclusively in stainless steel, features and elegant yet.*

*Eterno Ivica, thanks to its constant investments in research and development and an indispensable attention to quality, has created innovative, functional and effective solutions, able to respond in a timely manner to the most varied demands of modern construction.*

*Eterno products range and systems are designed and engineered maximize the effectiveness of construction, increasing the duration and value of the buildings.*

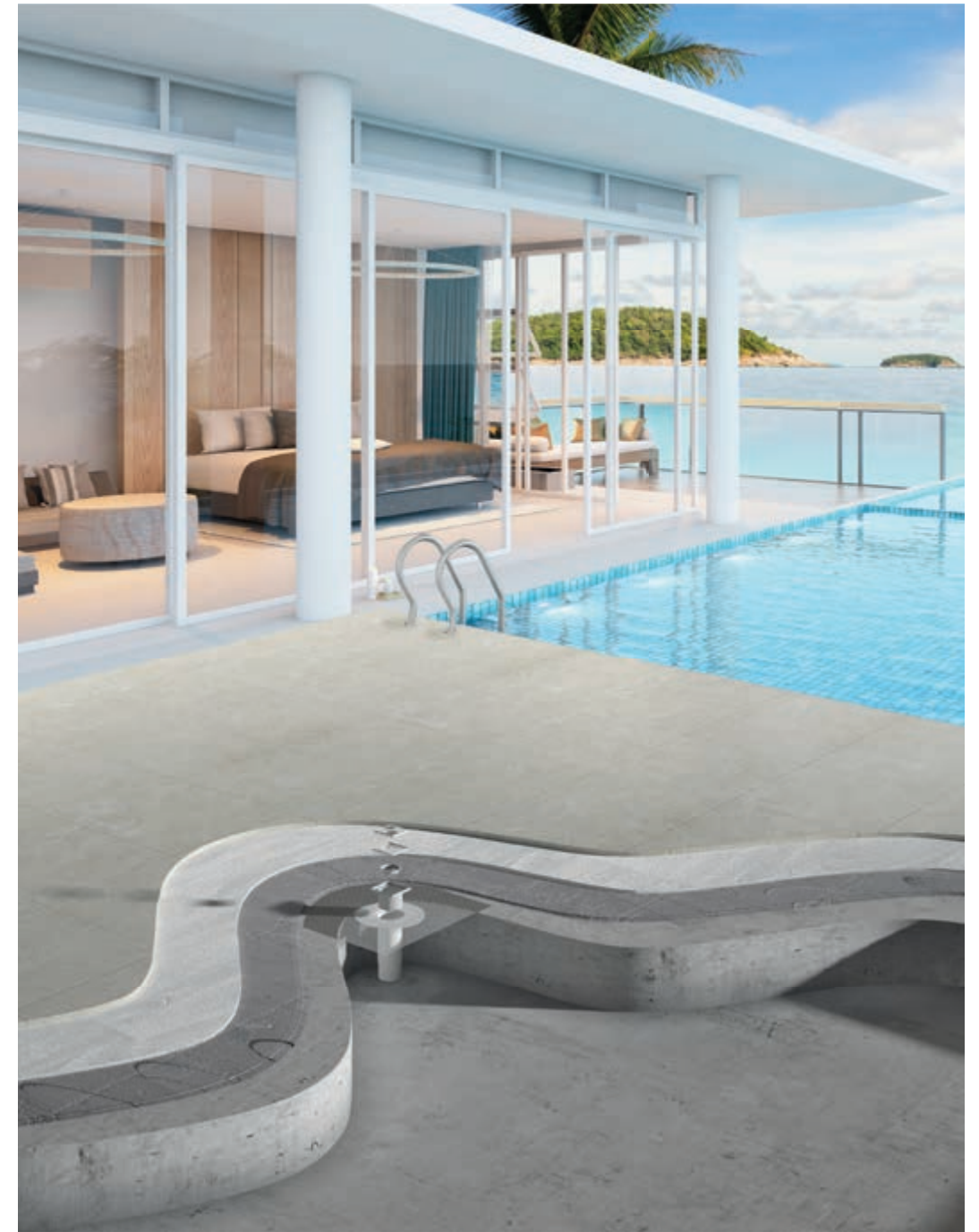

# ACCESSORI PER MEMBRANE LIQUIDE

## ACCESSORIES FOR LIQUID MEMBRANES

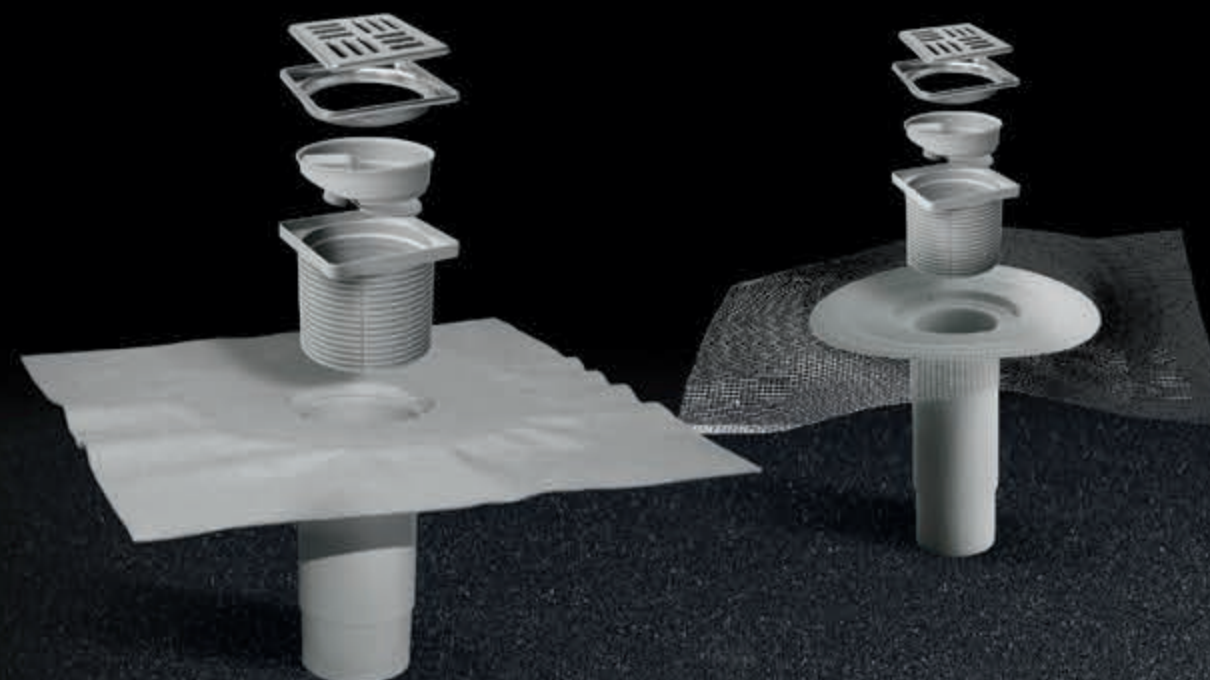

IT

Liquid è la serie di accessori compatibili con tutti i tipi di impermeabilizzazioni liquide e i cementi bicomponenti.

È l'unico sistema di scarichi capace di assicurare l'assoluta continuità tra l'impermeabilizzazione e gli accessori per la canalizzazione dell'acqua: grazie al processo di termo-fusione tra il fazzoletto in tessuto non tessuto o in fibra di vetro e la flangia del chiusino evita il pericolo di infiltrazioni in corrispondenza degli scarichi.

Composta da bocchettoni, esalatori e canalette, la gamma di prodotti è pensata per terrazze, balconi, docce, e permette una significativa riduzione del tempo di posa.

EN

*Liquid accessories are compatible with all types of liquid waterproofing or two-component cements.*

*It's the only drain system that's capable of ensuring absolute continuity between the waterproofing and the water channelling accessories, thanks to the thermo-fusion of the non-woven fabric or fiberglass sheet to the cover flange, thus preventing the risk of leaks around the drains.*

*Composed by drain outlets and channels, the product range is designed for terraces, balconies and showers, and provides for significantly reduced installation times.*

KIT LIQUID CON FLANGIA IN TNT  
*LIQUID KIT WITH TNT FLANGE*

KIT LIQUID CON FLANGIA IN FIBRA DI VETRO  
*LIQUID KIT WITH FIBERGLASS FLANGE*

ACCESSORI  
*ACCESSORIES*

BOCCHETTONI ANGOLARI  
*ANGULAR DRAIN*

ESALATORE PER IMPERMEABILIZZAZIONI LIQUIDE  
*VENT PIPE FOR LIQUID WATERPROOFING*

CANALETTA DOCCIA "LIQUID" IN PP  
*"LIQUID" SHOWER CHANNEL PP*

100

ETERNO IVICA · LIQUID

101

ETERNO IVICA · LIQUID



# KIT LIQUID CON FLANGIA IN TNT

## LIQUID KIT WITH TNT FLANGE

PP



- 1 Griglia in Acciaio Inox  
*Stainless Steel Grating*
- 2 Telaio in Acciaio Inox  
*Stainless Steel Frame*
- 3 Valvola anti intrusione Ø 50/75/82/90/100\*  
*Anti-intrusion system Ø 50/75/82/90/100\**
- 4 Prolunga Telescopica H 90 - H 50 - H 18  
*Telescopic Extension H 90 - H 50 - H 18*
- 5 Scanalatura per il deflusso dell'acqua  
*Water drainage grooves*
- 6 Scanalatura interna "acqua non stop"  
*"Non-stop water" internal grooves*
- 7 Flangia zigrinata sopra e sotto per migliorare l'ancoraggio degli impermeabilizzanti liquidi  
*Upper and lower knurled flange to improve the anchoring of the liquid waterproofing*
- 8 Telo in TNT ad alte prestazioni  
*Sheet made from high-performance non-woven fabric*
- 9 Chiusino scarico Verticale Ø 50/75/82/90/100  
*Vertical drain Ø 50/75/82/90/100*

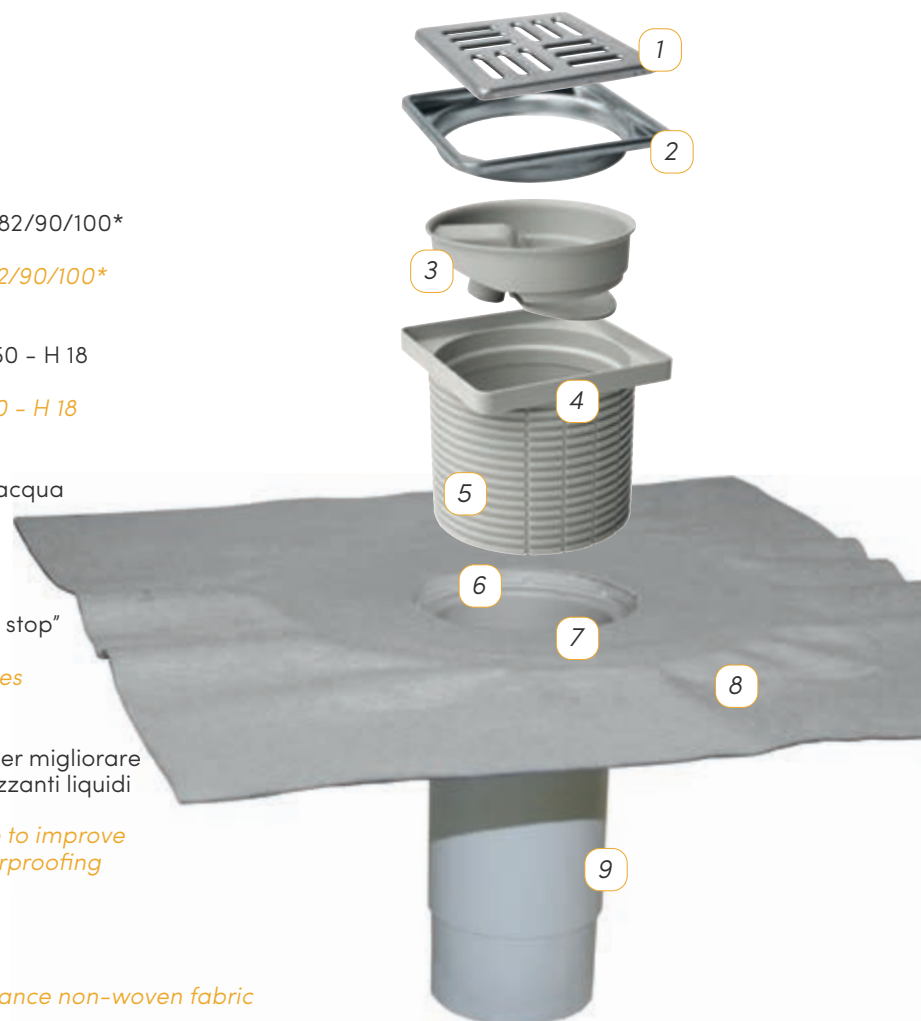

\* La Valvola anti intrusione dello scarico orizzontale è sempre Ø 100  
\* The horizontal drain's Anti-intrusion system is always Ø 100



Kit liquid telescopico verticale e orizzontale in TNT  
*Kit liquid telescopic with non-woven sheet*



TELO IN TNT AD ALTE PRESTAZIONI  
*HIGH-PERFORMANCE NON-WOVEN SHEET*

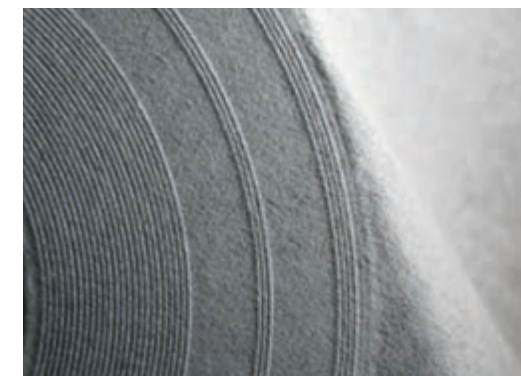

FLANGIA ZIGRINATA SOPRA E SOTTO  
PER MIGLIORARE L'ANCORAGGIO DEGLI  
IMPERMEABILIZZANTI LIQUIDI  
*UPPER AND LOWER KNURLED FLANGE TO  
IMPROVE THE ANCHORING OF THE LIQUID  
WATERPROOFING LAYERS*



GRIGLIA E TELAIO IN ACCIAIO INOX  
*STAINLESS STEEL GRATING AND FRAME*





# LIQUID LATERALE TELESCOPICO TNT

## LIQUID SIDE TELESCOPIC WITH NON-WOVEN SHEET

IT

Disponibile in tre diametri: 50-75-90 mm. Lo scarico orizzontale Liquid con TNT è dotato di un telo in tessuto non tessuto ad alte prestazioni che consente compatibilità soprattutto con gli impermeabilizzanti liquidi a base solvente. La struttura della flangia è provvista di una doppia zigrinatura (sopra e sotto) per migliorare ancor più l'aggancio dei prodotti liquidi; il basamento è inclinato per consentire un miglior deflusso dell'acqua ed evitare ristagni all'interno del chiusino. I gradini presenti all'interno del codolo, evitano l'effetto ventosa della Prolunga, consentendo il deflusso dell'acqua da infiltrazione.

EN

Available in three diameters: 50-75-90 mm. The Liquid side exit drain with non-woven sheet is provided with high performance non-woven material, that allows compatibility especially with solvent base liquid materials. The PP flange is provided with knurled surface on both sides, to improve the adherence of liquid waterproofing materials. Bottom part of the drain is provided with slope, to allow easy water drainage and prevent any stagnation of water inside the drain itself. Small steps on the upper part of the spigot allow dripping of water coming from any upper infiltration.



> POSA IN OPERA BOCCHETTONE SERIE "LIQUID"  
> ROOF DRAIN "LIQUID" INSTALLATION



### Kit liquid laterale telescopico TNT

Kit liquid side telescopic with non woven sheet



CODICE CODE	MISURA SIZE	PAG LISTINO PRICE LIST PAGE	PZ PZ	PZ PZ
A400021050	Kit Ø 50 con Prolunga H.90 mm, Valvola anti intrusione Ø 100 e Griglia con telaio inox <i>Kit Ø 50 with Extension element H.90 mm, Anti-intrusion system Ø 100 and inox Grating</i>	38	1	204
A400021075	Kit Ø 75 con Prolunga H.90 mm, Valvola anti intrusione Ø 100 e Griglia con telaio inox <i>Kit Ø 75 with Extension element H.90 mm, Anti-intrusion system Ø 100 and inox Grating</i>	38	1	204
A400021090	Kit Ø 90 con Prolunga H.90 mm, Valvola anti intrusione Ø 100 e Griglia con telaio inox <i>Kit Ø 90 with Extension element H.90 mm, Anti-intrusion system Ø 100 and inox Grating</i>	38	1	204

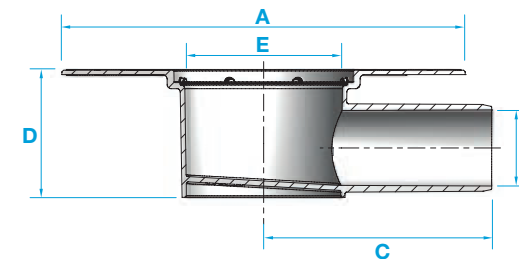

### BOCCHETTONE LIQUID LATERALE TELESCOPICO TNT

ROOF DRAIN LIQUID SIDE TELESCOPIC WITH NON-WOVEN SHEET

CODICE CODE	PER TUBI FOR PIPES	A	B	C	D	E	PAG LISTINO PRICE LIST PAGE	PZ PZ	PZ PZ
A400021050	Ø 50	230	49,5	130	70	89,9	38	18	252
A400021075	Ø 75	230	73,1	130	90	89,9	38	18	252
A400021090	Ø 90	230	88,6	130	120	89,9	38	18	252

# LIQUID VERTICALE TELESCOPICO TNT

## LIQUID VERTICAL TELESCOPIC WITH NON-WOVEN SHEET

IT

Disponibile in cinque diametri: 50-75-82-90-100 mm. Lo scarico verticale Liquid con TNT è dotato di un tessuto non tessuto ad alte prestazioni che consente compatibilità soprattutto con gli impermeabilizzanti liquidi a base solvente. La struttura della flangia è provvista di una doppia zigrinatura (sopra e sotto) per migliorare ancor più l'aggancio dei prodotti liquidi. I gradini presenti all'interno del codolo evitano l'effetto "ventosa" della Prolunga consentendo il deflusso dell'acqua da infiltrazione

EN

Available in five diameters: 50-75-82-90-100 mm. The Liquid vertical exit drain with non-woven sheet is provided with high performance non-woven material, that allows compatibility especially with solvent base liquid materials. The PP flange is provided with knurled surface on both sides, to improve the adherence of liquid waterproofing materials. Small steps on the upper part of the spigot allow dripping of water coming from any upper infiltration.



### Kit liquid verticale telescopico TNT

#### Roof drain liquid straight telescopic with non-woven sheet



CODICE CODE	MISURA SIZE	PAG LISTINO PRICE LIST PAGE	PZ 	PZ 
A400011050	Kit Ø 50 con Prolunga H.90 mm, Valvola anti intrusione Ø 50 e Griglia con telaio inox <i>Kit Ø 50 with Extension element H.90 mm, Anti-intrusion system Ø 50 and inox Grating</i>	39	1	108
A400011075	Kit Ø 75 con Prolunga H.90 mm, Valvola anti intrusione Ø 75 e Griglia con telaio inox <i>Kit Ø 75 with Extension element H.90 mm, Anti-intrusion system Ø 75 and inox Grating</i>	39	1	108
A400011082	Kit Ø 82 con Prolunga H.90 mm, Valvola anti intrusione Ø 82 e Griglia con telaio inox <i>Kit Ø 82 with Extension element H.90 mm, Anti-intrusion system Ø 82 and inox Grating</i>	39	1	108
A400011090	Kit Ø 90 con Prolunga H.90 mm, Valvola anti intrusione Ø 90 e Griglia con telaio inox <i>Kit Ø 90 with Extension element H.90 mm, Anti-intrusion system Ø 90 and inox Grating</i>	39	1	108
A400011100	Kit Ø 100 con Prolunga H.90 mm, Valvola anti intrusione Ø 100 e Griglia con telaio inox <i>Kit Ø 100 with Extension element H.90 mm, Anti-intrusion system Ø 100 and inox Grating</i>	39	1	108

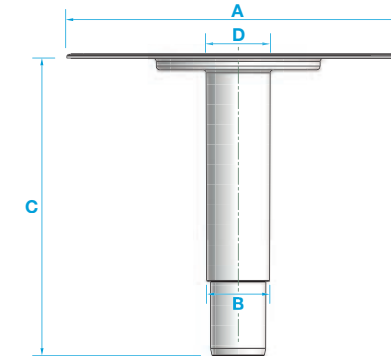

### BOCCHETTONE LIQUID VERTICALE TELESCOPICO TNT

#### ROOF DRAIN LIQUID STRAIGHT TELESCOPIC WITH NON-WOVEN SHEET

CODICE CODE	PER TUBI FOR PIPES	A	B	C	D	PAG LISTINO PRICE LIST PAGE	PZ 	PZ 
A401011050	Ø 50	230	42	200	43,3	39	9	144
A401011075	Ø 75	230	69,9	200	70,7	39	9	144
A401011082	Ø 82	230	75,5	200	76,8	39	9	144
A401011090	Ø 90	230	83,9	200	85,4	39	9	144
A401011100	Ø 100	230	94	200	95	39	9	144

# KIT LIQUID CON FLANGIA IN FIBRA DI VETRO

## LIQUID KIT WITH FIBERGLASS FLANGE

PP



- 1 Griglia in Acciaio Inox  
*Stainless Steel Grating*
- 2 Telaio in Acciaio Inox  
*Stainless Steel Frame*
- 3 Valvola anti intrusione Ø 50/75/82/90/100\*  
*Anti-intrusion system Ø 50/75/82/90/100\**
- 4 Prolunga Telescopica H 90 - H 50 - H 18  
*Telescopic Extension H 90 - H 50 - H 18*
- 5 Scanalatura per il deflusso dell'acqua  
*Water drainage grooves*
- 6 Scanalatura interna "acqua non stop"  
*"Non-stop water" internal grooves*
- 7 Flangia zigrinata sopra e sotto per migliorare l'ancoraggio degli impermeabilizzanti liquidi  
*Upper and lower knurled flange to improve the anchoring of the liquid waterproofing*
- 8 Rete in FV certificata ad alte prestazioni  
*High-performance certified Fiberglass mesh*
- 9 Chiusino scarico Verticale Ø 50/75/82/90/100  
*Vertical drain Ø 50/75/82/90/100*

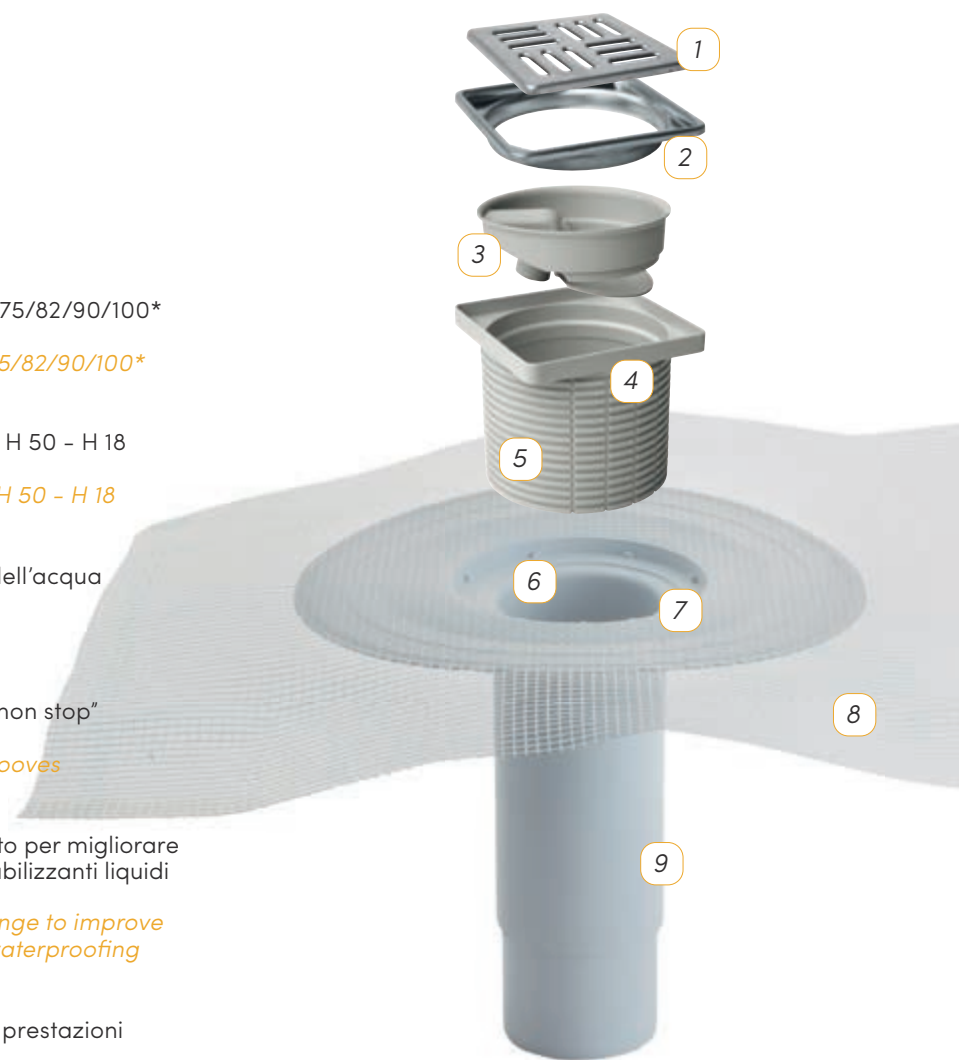

\* La Valvola anti intrusione dello scarico orizzontale è sempre Ø 100  
\* The horizontal drain's Anti-intrusion system is always Ø 100

108

ETERNO IVICA · LIQUID



### Kit liquid telescopico verticale e orizzontale FV *Kit liquid telescopic with fiberglass mesh*



#### TELO FV AD ALTE PRESTAZIONI HIGH-PERFORMANCE CERTIFIED FIBERGLASS MESH



#### SCANALATURA PER IL DEFLUSSO DELL'ACQUA WATER DRAINAGE GROOVES



#### GRIGLIA E TELAIO IN ACCIAIO INOX STAINLESS STEEL GRATING AND FRAME



109

ETERNO IVICA · LIQUID



# LIQUID LATERALE TELESCOPICO FV

## LIQUID SIDE TELESCOPIC WITH FIBERGLASS MESH

IT

Disponibile in tre diametri: 50-75-90 mm. Lo scarico orizzontale Liquid con FV è dotato di un rete in fibra di vetro certificata che consente compatibilità soprattutto con gli impermeabilizzanti liquidi a base acqua. La struttura della flangia è provvista di una doppia zigrinatura (sopra e sotto) per migliorare ancor più l'aggancio con i prodotti liquidi; il basamento è inclinato per consentire un miglior deflusso dell'acqua ed evitare ristagni all'interno del chiusino. I gradini presenti all'interno del codolo evitano l'effetto ventosa della Prolunga consentendo il deflusso dell'acqua da infiltrazione.

EN

Available in three diameters: 50-75-90 mm. The Liquid side exit drain with fiberglass mesh is provided of certified fiberglass mesh, that allows compatibility especially with water base liquid waterproofing materials. The PP flange is provided with knurled surface on both sides, to improve the adherence of liquid insulating materials. Bottom part of the drain is provided with slope, to allow easy water drainage and prevent any stagnation of water inside the drain itself. Small steps on the upper part of the spigot allow dripping of water coming from any upper infiltration.



### Kit liquid laterale telescopico FV

Kit liquid side telescopic with fiberglass mesh



CODICE CODE	MISURA SIZE	PAG LISTINO PRICE LIST PAGE	PZ PZ	PZ PZ
A400022050	Kit Ø 50 con Prolunga H.90 mm, Valvola anti intrusione Ø 100 e Griglia con telaio inox <i>Kit Ø 50 with Extension element H.90 mm, Anti-intrusion system Ø 100 and inox Grating</i>	40	1	204
A400022075	Kit Ø 75 con Prolunga H.90 mm, Valvola anti intrusione Ø 100 e Griglia con telaio inox <i>Kit Ø 75 with Extension element H.90 mm, Anti-intrusion system Ø 100 and inox Grating</i>	40	1	204
A400022090	Kit Ø 90 con Prolunga H.90 mm, Valvola anti intrusione Ø 100 e Griglia con telaio inox <i>Kit Ø 90 with Extension element H.90 mm, Anti-intrusion system Ø 100 and inox Grating</i>	40	1	204

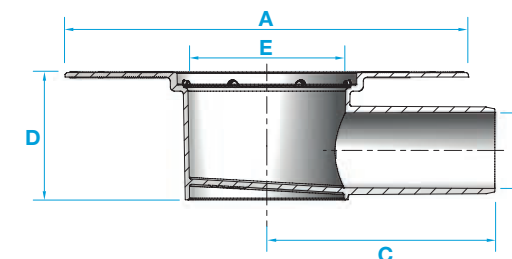
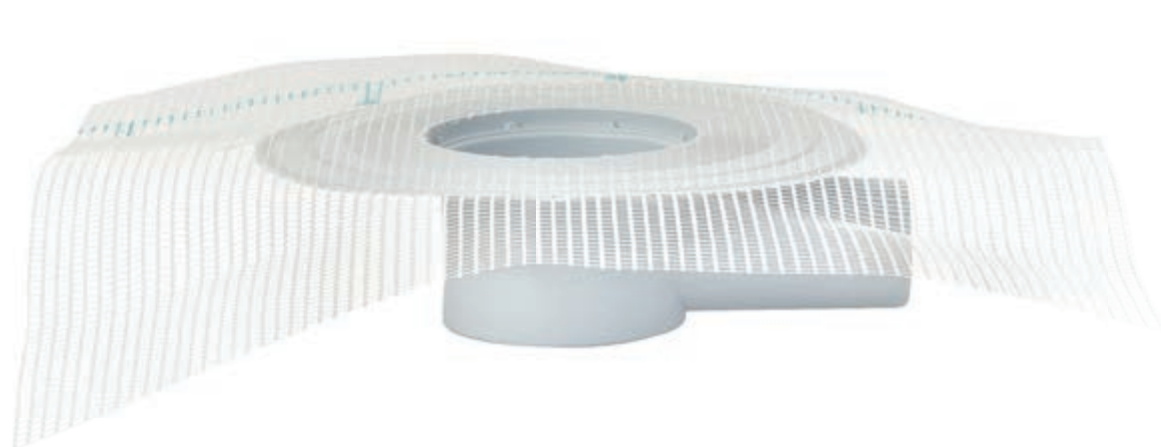

### BOCCHETTONE LIQUID LATERALE TELESCOPICO FV

ROOF DRAIN LIQUID SIDE TELESCOPIC WITH FIBERGLASS MESH

CODICE CODE	PER TUBI FOR PIPES	A	B	C	D	E	PAG LISTINO PRICE LIST PAGE	PZ PZ	PZ PZ
A401022050	Ø 50	230	49,5	130	70	89,9	40	18	252
A401022075	Ø 75	230	73,1	130	90	89,9	40	18	252
A401022090	Ø 90	230	88,6	130	120	89,9	40	18	252



# LIQUID VERTICALE TELESCOPICO FV

## LIQUID STRAIGHT TELESCOPIC WITH FIBERGLASS MESH

IT

Disponibile in cinque diametri: 50-75-82-90-100 mm. Lo scarico verticale Liquid con FV è dotato di una rete in fibra di vetro certificata che consente compatibilità soprattutto con gli impermeabilizzanti liquidi a base acqua. La struttura della flangia è provvista di una doppia zigrinatura (sopra e sotto) per migliorare ancor più l'aggancio dei prodotti liquidi. I gradini presenti all'interno del codolo evitano l'effetto "ventosa" della Prolunga consentendo il deflusso dell'acqua da infiltrazione.

EN

Available in five diameters: 50-75-82-90-100 mm. The Liquid vertical exit drain with fiberglass mesh is provided of certified fiberglass mesh, that allows compatibility especially with water base liquid waterproofing materials. The PP flange is provided of knurled surface on both sides, to improve the adherence of liquid waterproofing materials. Small steps on the upper part of the spigot allow dripping of water coming from any upper infiltration.

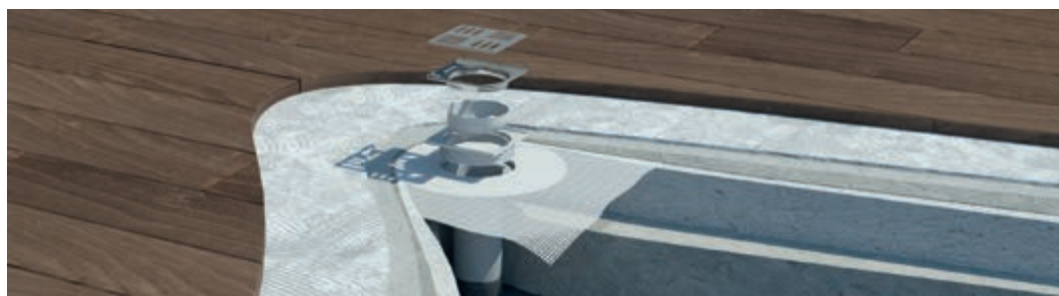

### Kit liquid verticale telescopico FV

#### Roof drain liquid straight telescopic with fiberglass mesh



CODICE CODE	MISURA SIZE	PAG LISTINO PRICE LIST PAGE	PZ 	PZ 
A400012050	Kit Ø 50 con Prolunga H.90 mm, Valvola anti intrusione Ø 50 e Griglia con telaio inox <i>Kit Ø 50 with Extension element H.90 mm, Anti-intrusion system Ø 50 and inox Grating</i>	41	1	108
A400012075	Kit Ø 75 con Prolunga H.90 mm, Valvola anti intrusione Ø 75 e Griglia con telaio inox <i>Kit Ø 75 with Extension element H.90 mm, Anti-intrusion system Ø 75 and inox Grating</i>	41	1	108
A400012082	Kit Ø 82 con Prolunga H.90 mm, Valvola anti intrusione Ø 82 e Griglia con telaio inox <i>Kit Ø 82 with Extension element H.90 mm, Anti-intrusion system Ø 82 and inox Grating</i>	41	1	108
A400012090	Kit Ø 90 con Prolunga H.90 mm, Valvola anti intrusione Ø 90 e Griglia con telaio inox <i>Kit Ø 90 with Extension element H.90 mm, Anti-intrusion system Ø 90 and inox Grating</i>	41	1	108
A400012100	Kit Ø 100 con Prolunga H.90 mm, Valvola anti intrusione Ø 100 e Griglia con telaio inox <i>Kit Ø 100 with Extension element H.90 mm, Anti-intrusion system Ø 100 and inox Grating</i>	41	1	108

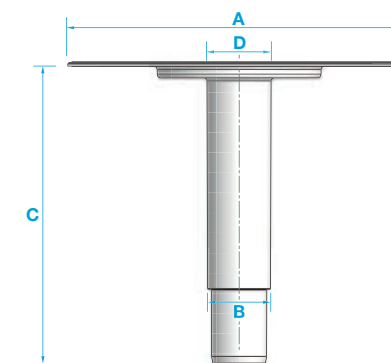

### BOCCHETTONE LIQUID VERTICALE TELESCOPICO FV

#### ROOF DRAIN LIQUID STRAIGHT TELESCOPIC WITH FIBERGLASS MESH

CODICE CODE	PER TUBI FOR PIPES	A	B	C	D	PAG LISTINO PRICE LIST PAGE	PZ 	PZ 
A401012050	Ø 50	230	42	200	43,3	41	9	144
A401012075	Ø 75	230	69,9	200	70,7	41	9	144
A401012082	Ø 82	230	75,5	200	76,8	41	9	144
A401012090	Ø 90	230	83,9	200	85,4	41	9	144
A401012100	Ø 100	230	94	200	95	41	9	144

# ACCESSORI

## ACCESSORIES

PP

INOX

INOX

### GRIGLIA CON TELAIO

#### GRATING WITH FRAME

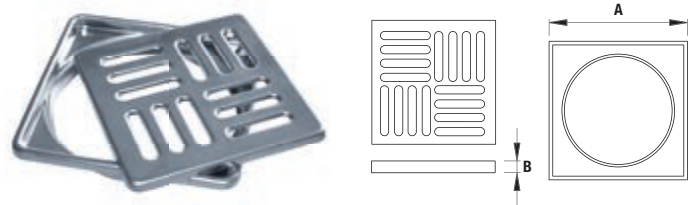

Costruita in acciaio inox è adattabile a tutti gli scarichi e va inserita sopra la Prolunga.

*Made in stainless steel, it's suitable to all our drains and used on top of the Extension Element.*

PP

### PROLUNGA H90

#### EXTENSION ELEMENT H90

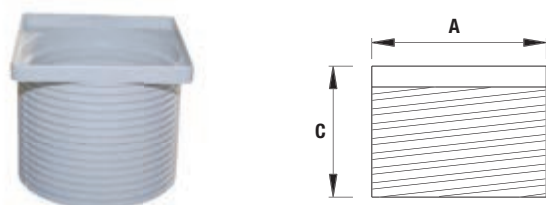

Da posizionarsi sopra lo scarico, permette di compensare pacchetti impermeabili di spessori variabili. La Prolunga è infatti facilmente tagliabile per essere adattata all'altezza richiesta dal pacchetto isolante.

*To be placed on top of the floor drain, it allows the thickness' compensation of the insulation system. The Extension Element in fact can be easily cut to reach the desired highness.*



114

ETERNO IVICA · LIQUID

PP

### PROLUNGA H50

#### EXTENSION ELEMENT H50



Da posizionarsi sopra lo scarico, permette di compensare pacchetti impermeabili di spessori variabili. La Prolunga è infatti facilmente tagliabile per essere adattata all'altezza richiesta dal pacchetto isolante.

*To be placed on top of the floor drain, it allows the thickness' compensation of the insulation system. The Extension Element in fact can be easily cut to reach the desired highness.*

### PROLUNGA H18

#### EXTENSION ELEMENT H18



Adatta alle applicazioni senza pacchetto isolante o comunque in tutti quei casi dove si posano direttamente colla e piastrelle sopra il piano del bocchettone.

*Suitable for applications without insulation or in all those cases where adhesive and tiles are laid directly on the drain hole surface.*

### VALVOLA ANTI INTRUSIONE

#### ANTI-INTRUSION SYSTEM



Disponibile in 5 diametri, va inserito sopra la Prolunga nel caso di scarico orizzontale o direttamente nel codolo solo nel caso di scarico verticale.

*Available in 5 diameters, it has to be inserted inside the Extension Element when using a side exit drain, or directly inside the spigot of the vertical drain.*

CODICE CODE	DESCRIZIONE DESCRIPTION	Ø	A	B	C	PAG LISTINO PRICE LIST PAGE	PZ PZ	PZ PZ
A430100100	Griglia in acciaio inox <i>Stainless steel grid</i>	-	104	5	-	42	1	-
A430100120	Telaio in acciaio inox <i>Stainless steel frame</i>	-	104	5	-	42	1	-
A420100078	Prolunga H90 <i>Extension Element H90</i>	-	99	-	88	42	1	-
A420100037	Prolunga H50 <i>Extension Element H50</i>	-	99	-	48	42	1	-
A420100018	Prolunga H18 <i>Extension Element H18</i>	-	99	-	17,5	42	1	-
A410010050	Valvola anti intrusione <i>Anti-intrusion system</i>	50	-	-	-	43	1	-
A410010075	Valvola anti intrusione <i>Anti-intrusion system</i>	75	-	-	-	43	1	-
A410010082	Valvola anti intrusione <i>Anti-intrusion system</i>	82	-	-	-	43	1	-
A410010090	Valvola anti intrusione <i>Anti-intrusion system</i>	90	-	-	-	42	1	-
A410010100	Valvola anti intrusione <i>Anti-intrusion system</i>	100	-	-	-	42	1	-

115

ETERNO IVICA · LIQUID

# BOCCHETTONI ANGOLARI

## ANGULAR DRAIN

PP



IT

Compatibilità totale con tutte le tipologie di guaine liquide, cementi bicomponenti, monocomponenti e plastivi. Grazie alla termofusione del tessuto-non-tessuto e della fibra di vetro alla flangia, si prevengono infiltrazioni d'acqua e si garantisce durata illimitata.

L'estrema facilità di posa rendono questi bocchettone angolari la scelta perfetta in ogni situazione applicativa.

EN

*Complete compatibility with all types of liquid membranes, two-component and single-component cements and plastivo products. Thanks to the thermo-fusion of the non-woven fabric or fiberglass sheet to the cover flange, this one-of-a-kind system is capable of preventing leaks around the drain outlets.*

*Thanks to their extreme ease of installation and complete compatibility with the waterproofing layer, these angular drain outlets are perfect for any application.*



> POSA IN OPERA DEL BOCCHETTONE ANGOLARE LIQUID PER POGGIOLI  
> INSTALLATION OF LIQUID ANGULAR DRAIN FOR BALCONIES

116

ETERNO IVICA · LIQUID



### BOCCHETTONE ANGOLARE LIQUID PER POGGIOLI FV

#### ANGULAR LIQUID DRAIN FOR BALCONIES WITH FIBERGLASS MESH



CODICE CODE	DESCRIZIONE DESCRIPTION	PAG LISTINO PRICE LIST PAGE	PZ 	PZ 
A043347121	Lunghezza / Length 347 Sezione / Section 57x48 Avorio / Ivory	44	5	-
A043347123	Lunghezza / Length 347 Sezione / Section 57x48 Rame / Copper	44	5	-



### BOCCHETTONE ANGOLARE LIQUID PER POGGIOLI TNT

#### ANGULAR LIQUID DRAIN FOR BALCONIES WITH NON-WOVEN SHEET



CODICE CODE	DESCRIZIONE DESCRIPTION	PAG LISTINO PRICE LIST PAGE	PZ 	PZ 
A043347131	Lunghezza / Length 347 Sezione / Section 57x48 Avorio / Ivory	44	5	-
A043347133	Lunghezza / Length 347 Sezione / Section 57x48 Rame / Copper	44	5	-

117

ETERNO IVICA · LIQUID



# ESALATORE PER IMPERMEABILIZZAZIONI LIQUIDE

## VENT PIPE FOR LIQUID WATERPROOFING

PP



IT

### La giusta via di uscita

L'Esalatore Liquid rappresenta la giusta via di uscita per qualsiasi tipo di esalazione, vapore e condensa, e la soluzione ai gravi problemi di infiltrazioni d'acqua causate dal rigonfiamento dello strato impermeabile liquido, facilmente fessurabile con i cambi climatici.

Con il fazzoletto in TNT ad alte prestazioni elastiche, fuso meccanicamente alla flangia dell'esalatore, viene assicurata la saldatura in un unico strato tra il prodotto e l'armatura, che crea una impermeabilizzazione continua ed oltremodo efficace.

L'Esalatore Liquid è compatibile con tutti i prodotti impermeabilizzanti liquidi e cementi bicomponenti presenti sul mercato.

EN

### The right exit

*The Liquid Vent is the right accessory for the exit of steam and condensation, and the solution for serious issues resulting from water infiltration caused by the swelling of the liquid waterproof layer, which can easily crack with changes in weather conditions.*

*The TNT high-performance elastic sheet or the fiberglass mesh, which are mechanically bonded to the vent's flange, ensure single layer welding between the product and the sheet, thus creating continuous and extremely effective waterproofing.*

*The Liquid Vent is compatible with all available liquid waterproofing products and bicomponent cements in the market.*

1 Cupola

Cup

2 Esalatore

Vent Pipe

3 Flangia con parte inferiore corredata da convogliatori di vapore

Flange with embossed points for vapor passage

4 TNT ad alte prestazioni

High-performance textile sheet



118

ETERNO IVICA · LIQUID

# VANTAGGI

## ADVANTAGES

IT

- Impermeabilizzazione continua
- Tecnologia innovativa
- Diminuzione del rischio di infiltrazioni
- Velocità di posa

EN

- Continuous waterproofing
- Innovative technology
- Less infiltration leaks
- Quick installation



CODICE CODE	TIPO TYPE	H	ESTERNO EXTERNAL	PAG LISTINO PRICE LIST PAGE	PZ PZ	PZ PZ
D021200075	TNT	200	Ø 75	45	1	-

> POSA IN OPERA ESALATORE LIQUID  
> VENT PIPE INSTALLATION

119

ETERNO IVICA · LIQUID



# CANALETTA DOCCIA "LIQUID" IN PP

## "LIQUID" SHOWER CHANNEL PP

PP



IT

### Kit canaletta "liquid" in polipropilene

- Altezza costruttiva ridotta: soltanto 6,2 cm
- Facilità di pulizia fino al tubo di scarico (Ø 40 mm)
- Elevata resistenza agli agenti chimici
- Eccellente compatibilità con il pacchetto impermeabile, grazie al TNT in dotazione
- Sifone antiodore
- Drenaggio 30 l/min

EN

### Kit "liquid" channel pp

- Low height of only 6.2 cm
- Easy demountability and cleanability up to pipe (Ø 40 mm)
- High resistance to chemicals
- Secure connection to the waterproofing
- Anti-odour system
- Flow rate 30 l/min

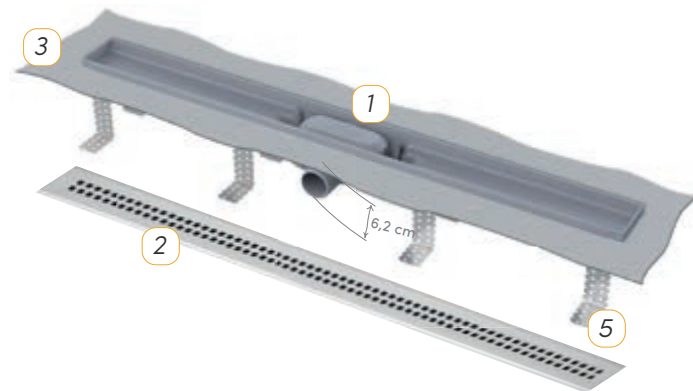
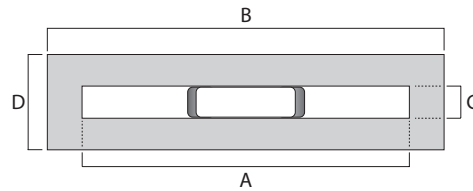
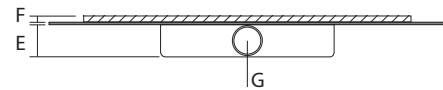

120

ETERNO IVICA · LIQUID

IL KIT CONTIENE

KIT CONTAINS





- 1 Canaletta in PP  
*PP channel*
- 2 Griglia (acciaio Inox)  
*Stainless steel grating*
- 3 Bandella in TNT perimetrale  
*Butyl-textile tape*
- 4 Sifone antiodore  
*Anti-odor system*
- 5 Kit di fissaggio (bulloni, pioli, 8 piedini)  
*Anchor Kit (screws, dowels, 8 legs)*

121

ETERNO IVICA · LIQUID

## KIT CANALETTA DOCCIA IN PP

## ROOF DRAIN LIQUID STRAIGHT TELESCOPIC WITH FIBERGLASS MESH

CODICE CODE	DESCRIZIONE DESCRIPTION	A	B	C	D	E	F	G	PAG LISTINO PRICE LIST PAGE	PZ 	PZ 
1051100075	Kit Canaletta Doccia con TNT <i>Shower Channel Kit with non woven sheet</i>	750	810	62	121	62	12	40	45	1	-
1051100085	Kit Canaletta Doccia con TNT <i>Shower Channel Kit with non woven sheet</i>	850	910	62	121	62	12	40	45	1	-
1051100095	Kit Canaletta Doccia con TNT <i>Shower Channel Kit with non woven sheet</i>	950	1010	62	121	62	12	40	45	1	-



**MADE IN ITALY**

**ETERNO IVICA SRL**

Via Austria, 25/E  
Z.I. Sud - 35127 Padova - Italy

**T. ITA** +39 049 8530101  
**T. EXP** +39 049 8530102  
**FAX** +39 049 8530111

[www.eternoivica.com](http://www.eternoivica.com)  
[eternoivica@eternoivica.com](mailto:eternoivica@eternoivica.com)

**eternoivica** |







MADE IN ITALY

eternoivica

**ETERNO IVICA SRL**

via Austria 25 / E  
Z.I. Sud - 35127 Padova - Italy

ITA +39 049 8530101  
EXP +39 049 8530102  
FAX +39 049 8530111

[eternoivica@eternoivica.com](mailto:eternoivica@eternoivica.com)  
[www.eternoivica.com](http://www.eternoivica.com)